

# Best<sup>®</sup> medical *international*

## Product Catalog



© 2013–2020 Best Medical International, Inc.

Best Medical International, Inc. 7643 Fullerton Road, Springfield, Virginia 22153 USA  
Tel: 703-451-2378 800-336-4970 Fax: 703-451-5228 [www.bestmedical.com](http://www.bestmedical.com)

BMI\_CATALOG\_Complete\_v2(\_03# 2020\_web

**Best Medical can  
provide any standard  
or customized  
configuration made  
to your exact  
specifications, sterile  
or non-sterile,  
shipped within 24  
hours — worldwide!**

## **Contact us:**

**Best Medical International  
7643 Fullerton Road  
Springfield, Virginia 22153 USA**

**Tel: 703-451-2378 • 800-336-4970**

**Fax: 703-451-5228**

**[www.bestmedical.com](http://www.bestmedical.com) • [www.teambest.com](http://www.teambest.com)**



## Mission Statement

*Everyone deserves the best health care. Our goal is to work with medical professionals to provide the Best products and services. As a leader in innovative technology, our mission is to uphold our reputation for excellence in the health care field by developing, manufacturing, and delivering cost-effective, high quality products to benefit patients around the world.*

## Corporate Values

*Fulfilling our mission requires a dedicated employee team—one that is committed to uncompromised quality and safety, and fostering a sense of pride in the company.*

## Best employees will:

- *Honor the dignity and uniqueness of each person, including fellow employees, customers, distributors, and vendors, through their actions, words, and behavior. They will treat others with respect, as they would wish to be treated.*
- *Embrace the spirit of cooperation and teamwork for which Best Medical is known, an environment which supports and recognizes effort and results.*
- *Promote and practice open and honest communication at all times.*
- *Listen to others and remain open to suggestions at all times, as we focus on achieving excellence in our work.*
- *Attract and retain leaders with exceptional abilities and integrity.*
- *Ensure all resources are managed in a responsible and effective manner.*



# Best ADVANTAGE

- Best Medical International is the **ONLY** supplier of Iridium-192 and Gold-198 seeds.
- We are the first and only provider of Iridium-192 in nylon ribbons in a wide range of activities.
- We are the first and only company to provide custom service for Gold-198 permanent implants, as well as a wide range of activities.
- We are the first and only company that will call our customers the morning after shipping to inform them of mode of transportation and expected arrival time.
- We can supply Ir-192, Au-198, Pd-103, I-125 and Brachytherapy accessories on a single Purchase Order.
- We ship most materials within 24 hours of receipt of the order.

# Catalog Table of Contents

## Afterloading Catheters & Buttons

Nylon Afterloading Tubes . . . . . 1  
Buttons . . . . . 3  
Bronchial Tube . . . . . 5  
Esophageal Applicator (Single Tube) . . . . . 7  
HDR Remote Afterloading Accessories . . . . . 8

## Applicators

Round-Handle Fletcher-Suit-Delclos Applicator Set (640R) . . . . . 10  
Round Handle Fletcher-Suit-Delclos Applicator Set with Bracket (640RB) . . . . . 11  
Fletcher-Suit-Delclos Mini-Ovoid Applicator Set (640M) . . . . . 12  
Delclos Mini-Ovoid Applicator Set with Bracket Assembly (640MRB) . . . . . 13  
Burnett Afterload Vaginal Applicator (700A) . . . . . 14  
Delclos Uterine/Vaginal Afterloading Applicator and Dome Assembly (670) . . . . . 15  
Dummy Sources (Cesium) . . . . . 16  
Mick® 200-TPV Applicator Kit . . . . . 17  
Ordering Information: Optional Instrumentation and Accessories . . . . . 18

## Brachytherapy Kits

Interstitial Implant Instrument Set . . . . . 19  
Brachytherapy Kit . . . . . 20  
Sterile Brachytherapy Kits . . . . . 21  
Implant Kit . . . . . + + + + 23

(Continued on next page)



**Brachytherapy Needles**

Best Mick Type Needles ..... 24

Best Prostate Seeding Needles ..... 25

Prostate Stabilization Set Needles ..... 26

Needles ..... 27

**Dummy Ribbons**

Nylon and Cable Dummy Ribbons ..... 28

**Flexi-Needles**

Flexi-Needles ..... 29

Flexi-Needle Combinations ..... 30

Sterile Flexi-Needles ..... 35

**Gold Fiducial Markers & Marker Kits**

Marker Kit/Gold Fiducial Markers ..... 40

Sterile Loose Gold Markers with Forceps ..... 41

Sterile Loose Stainless Steel Markers with Forceps ..... 41

Sterile Iodine Dummy Sources in a Vial ..... 41

Sterile Fiducial Marker Kits • 18 GAUGE • 0.8 mm OD

- 10 cm Long Needles ..... 42
- 15 cm Long Needles ..... 43
- 20 cm Long Needles ..... 43
- 30 cm Long Needles ..... 44

Sterile Fiducial Marker Kits • 18 GAUGE • 1.0 mm OD

- 10 cm Long Needles ..... 45
- 15 cm Long Needles ..... 46
- 20 cm Long Needles ..... 47
- 30 cm Long Needles ..... 48

*(Continued on next page)*

Sterile Fiducial Marker Kits • 17 GAUGE • 1.2 mm OD	
- 20 cm Long Needles .....	49
- 30 cm Long Needles .....	50
Sterile Fiducial Marker STRAND Kits • 18 GAUGE • 0.8 mm OD	
- 10 cm Long Needles .....	51
- 15 cm Long Needles .....	52
- 20 cm Long Needles .....	53
Sterile Fiducial Marker STRAND Kits • 17 GAUGE • 0.8 mm OD	
- 30 cm Long Needles .....	54
Sterile Fiducial Marker STRAND Kits • 17 GAUGE • 1.0 mm OD	
- 10 cm Long Needles .....	55
- 20 cm Long Needles .....	56
Sterile Fiducial Marker STRAND Kits • 16 GAUGE • 1.2 mm OD	
- 20 cm Long Needles .....	57
Sterile ROUND HUB Needles with Marker Strand & Iodine Dummy Seed • 18 GAUGE • 0.8 mm OD	
- 10 cm Long Needles .....	58
- 15 cm Long Needles .....	58
- 20 cm Long Needles .....	59
Sterile SQUARE HUB Needles with Marker Strand & Iodine Dummy Seed • 18 GAUGE • 0.8 mm OD	
- 10 cm Long Needles .....	60
- 15 cm Long Needles .....	60
- 20 cm Long Needles .....	61
Sterile Fiducial Marker with SPACERS Kits • 18 GAUGE • 0.8 mm OD	
- 20 cm Long Needles .....	62
Sterile Fiducial Marker with SPACERS Kits • 18 GAUGE • 1.0 mm OD	
- 20 cm Long Needles .....	63
Sterile Fiducial Marker with SPACERS Kits • 17 GAUGE • 1.2 mm OD	
- 20 cm Long Needles .....	64
Non-Sterile Loose Gold Markers with Forceps .....	65
Rectal Marker Kit with Anus Marker .....	66
Anderson Marker Kit .....	67
Adjustable Marker Kit .....	67
Stainless Steel Markers .....	67

(Continued on next page)



**Radioactive Seeds**

Best<sup>®</sup> Iodine-125 and Best<sup>®</sup> Palladium-103 Sources . . . . . 68

Breast Localization Needles with Iodine-125 Seeds . . . . . 69

Sterile & Non-Sterile Seed Products . . . . . 70

Iridium-192 and Gold-198 Information . . . . . 72

Flood Sources . . . . . 73

Dose Calibrator Vials . . . . . 75

Markers and Rulers . . . . . 75

**Stainless Steel Needles**

Implant Needles . . . . . 76

Curved Needles . . . . . 77

Template Needles With Funnel and Cap . . . . . 78

Template Needles . . . . . 79

Needle Implanters . . . . . 80

Diddler-Needle Adjustment Tool . . . . . 81

*(Continued on next page)*



# Templates

Syed/Neblett Gyn Template #1/Kit . . . . . 82

Syed/Neblett Gyn Template #2/Kit . . . . . 83

Syed/Neblett Gyn Template #3/Kit . . . . . 84

Syed/Neblett Prostate Template/Kit . . . . . 85

Syed/Neblett Rectal Template/Kit . . . . . 86

Syed/Neblett Urethral Template/Kit . . . . . 87

Disposable Gyn Template/Kit . . . . . 88

Disposable Prostate Template (with Needle Hole) . . . . . 90

Disposable Prostate Template (with Small Hole) . . . . . 91

Disposable Rectal Template . . . . . 92

Templates (B&K) . . . . . 94



# Best<sup>®</sup> medical international

## Afterloading Catheters & Buttons

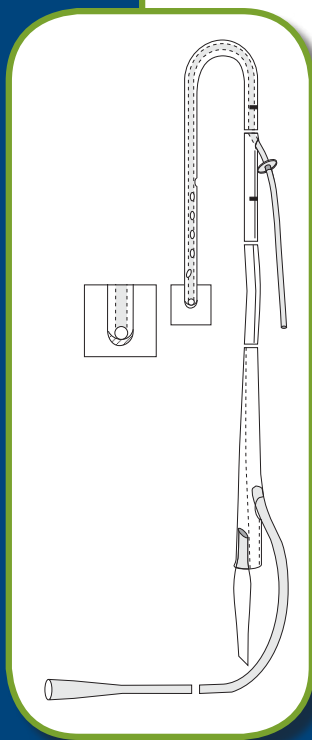
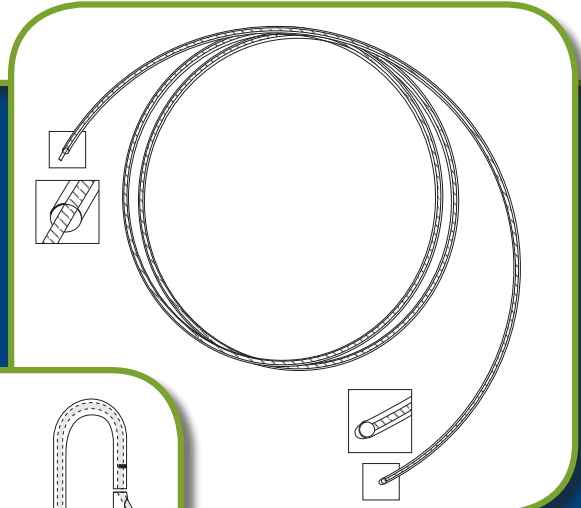
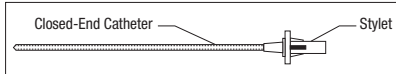
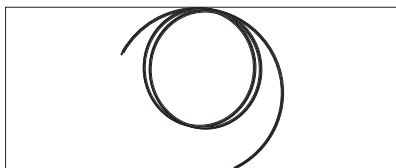
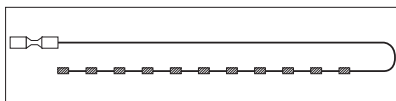
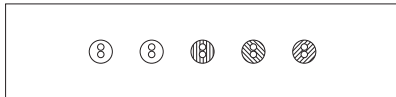
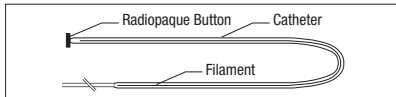
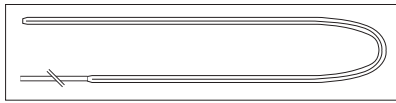
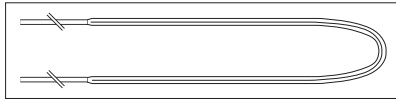
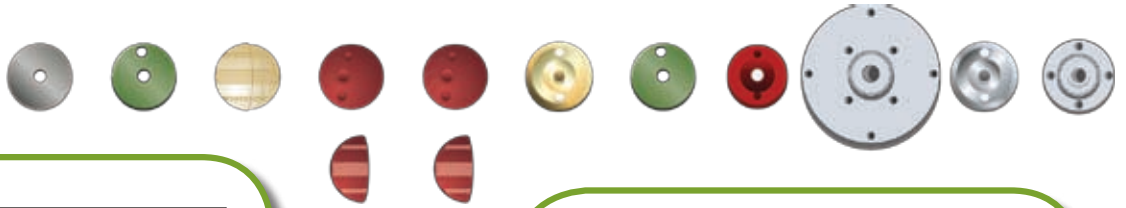

## Nylon Afterloading Tubes

The Nylon Afterloading Tubes are of different types: Single Leader, Double Leader, and G.B. Technique Tube [Outer Diameter: 0.065"; Inner Diameter: 0.051"]

### Single Leader Tube

Part # 180-30

Sterile Part # 1099

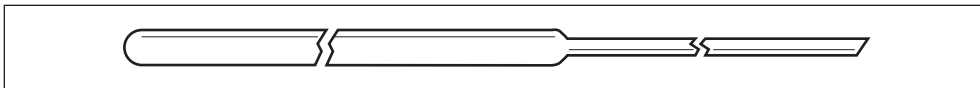

This tube is of 16G and will have a leader at one end so as to thread through the implant needle. Standard length of these tubes are 30 cm and leader 30 cm. One end of this tube is closed. This tube is also known as Blind End Tube.

### Double Leader Tube

Part # 184-30

Sterile Part # 1101

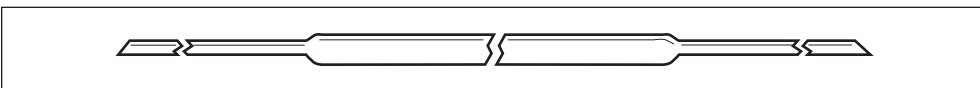

This tube is the same as Single Leader, but with leaders on both ends. The length of the tube is 30 cm and both leaders measure 30 cm each.

### Single Leader G.B. Tech Tube

Part # 187-30

Sterile Part # 1103

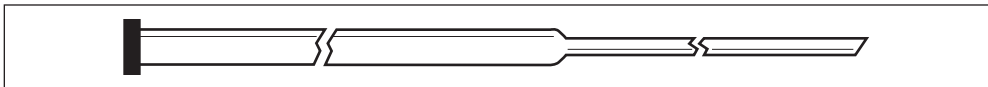

This 16G Single Leader Tube has a flat end closed and will have a flat or half moon button at the end. Other end will have 30 cm leader.

### Above Tubes Are Also Available Sterile With:

Custom lengths and diameters with Filament, Cable, or Cable Dummy Ribbon.

Part #	Description
962	V Source Catheters in a Pouch
1074	0.061" G.B. Catheters with Cable in a Pouch (quantity of 5)
1094	0.065" G.B. Catheters with Cable in a Pouch (quantity of 5)
1155	1.9 mm Polyacetyl G.B. Catheter without Filament in a Pouch (quantity of 5)
1195	1.9 mm Polyacetyl G.B. Catheter with Filament in a Pouch (quantity of 5)
1198	1.9 mm Polyacetyl G.B. Catheter with Cable in a Pouch (quantity of 5)

*continues on next page*

### Catheters are for one time use only.











**CAUTION:** This product should be carefully inspected by your staff prior to clinical use and should be used by authorized personnel only.



Part #	Description
1342	1.7 mm O.D. Blind End Catheters with Marking in a Pouch (quantity of 5)
1345	1.7 mm O.D. Double Leader Catheters with Marking in a Pouch (quantity of 5)
1348	1.7 mm O.D. G.B.T. Catheters with Marking in a Pouch (quantity of 5)
1411	0.065" O.D. Single Leader Catheter with Luer Lock in a Pouch (quantity of 5)
1415	13G Blind End Catheter with Male Connector in a Pouch
1426	Varisource Connecting Tube in a Pouch
1495	Nylon Filament in a Pouch
1497	1.7 mm O.D. After Loading Double Leader Catheters with Cables in a Pouch
1502	Implant Kit
1506	Five Colors of 0.065" O.D. Blind End Catheters in a Pouch
1716	Single Leader Catheter 0.078" O.D. with Luer Lock & Button in a Pouch (quantity of 5)
1727	1.8 mm O.D. G.B.T. Catheters with Filament in a Pouch (quantity of 5)
1733	1.7 mm O.D. Blind End Catheters with Filament in a Pouch (quantity of 5)
1742	Buttons in a Pouch
1780	0.061" Blind End Catheters with Cable in a Pouch
1782	1.9 mm O.D. G.B.T. Catheters with Filament and Marking in a Pouch (quantity of 5)
1793	0.078" O.D. with Male Luer Lock on Both Ends in a Pouch
1796	0.078" O.D. with Male & Female Luer Lock on the Ends in a Pouch
1807	0.065" O.D. Blind End Catheters with Cable in a Pouch (quantity of 5)
1825	1.9 mm O.D. Blind End Catheters with Markings in a Pouch (quantity of 5)
1834	0.068" Closed End Tube with Female Luer Lock & Markings in a Pouch

**Catheters are for one time use only.**

**CAUTION:** This product should be carefully inspected by your staff prior to clinical use and should be used by authorized personnel only.

Buttons			
	Part #	Sterile Part #	Description
	494		Flat Tungsten
	208	1078	Flat Nylon
	240	1673	Full Moon Nylon
	312	1111	Half Moon Nylon
	242	1109	Half Moon Radiopaque
	239		Aluminum
	221	1107	Flat Radiopaque
	244	1625	Flat Countersink
	300	1865	Flat Large Flexible
	238	1080	Flat Stainless Steel
	238-1		Non-sterile Stainless Steel Buttons in a Bag (1.6 mm)
	238-2		Non-sterile Stainless Steel Buttons in a Bag (1.7 mm)
	238-3		Non-sterile Stainless Steel Buttons in a Bag (1.9 mm)
	301	1863	Flat Small Flexible

**Different hole sizes are available.**

*continues on next page*

**CAUTION:** This product should be carefully inspected by your staff prior to clinical use and should be used by authorized personnel only.



<i>Part #</i>	<i>Description</i>
1138	Colored Radiopaque Half Moon Buttons in Pouch (1.6 mm)
1140	Colored Radiopaque Half Moon Buttons in Pouch (1.7 mm)
1142	Colored Radiopaque Half Moon Buttons in Pouch (1.9 mm)
1489	Colored Nylon Half Moon Buttons in Pouch (1.6 mm)
1491	Colored Nylon Half Moon Buttons in Pouch (1.7 mm)
1493	Colored Nylon Half Moon Buttons in Pouch (1.9 mm)
1680	Colored Radiopaque Flat Buttons in Pouch (1.6 mm)
1682	Colored Radiopaque Flat Buttons in Pouch (1.7 mm)
1684	Colored Radiopaque Flat Buttons in Pouch (1.8 mm)
1686	Colored Radiopaque Flat Buttons in Pouch (1.9 mm)
1688	Colored Nylon Flat Buttons in Pouch (1.6 mm)
1690	Colored Nylon Flat Buttons in Pouch (1.7 mm)
1692	Colored Nylon Flat Buttons in Pouch (1.9 mm)
1747	Colored Radiopaque Countersunk Buttons in a Pouch (1.9 mm)
1787	Nylon Flat Countersunk Buttons in a Pouch
1790	Colored Nylon Countersunk Buttons in a Pouch (1.9 mm)



**CAUTION:** This product should be carefully inspected by your staff prior to clinical use and should be used by authorized personnel only.

## Bronchial Tube

Part # 191-; Part # 192-; Part #518-

**Discription:** This tube is closed at one end with a cable throughout and a marker at the closed end. The cable enables the tube to take the curvature when it is pushed in, without kinking. The marker is to show position of the tube in radiograph. See below for list of available lengths and diameters.

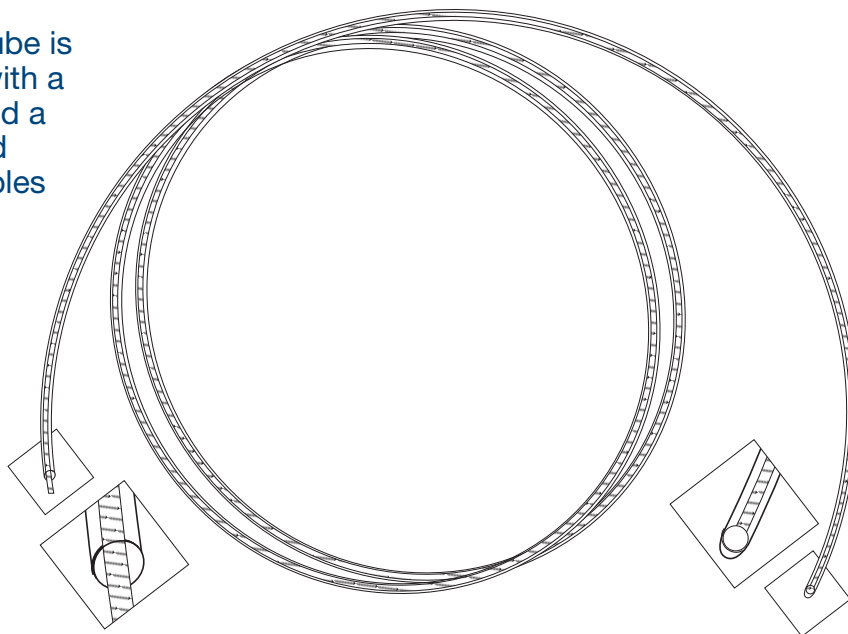

Part #	Product
791	Nylon Bronchial Tube 120 cm 1.7 mm O.D. (sterile)
191-120	Nylon Bronchial Tube 120 cm 1.7 mm O.D. (non-sterile)
191-150	Nylon Bronchial Tube 150 cm 1.7 mm O.D. (non-sterile)
191-180	Nylon Bronchial Tube 180 cm 1.7 mm O.D. (non-sterile)
191-240	Nylon Bronchial Tube 240 cm 1.7 mm O.D. (non-sterile)
191-300	Nylon Bronchial Tube 300 cm 1.7 mm O.D. (non-sterile)
1082	Nylon Bronchial Tube 120 cm 1.8 mm O.D. (sterile)
518-120	Nylon Bronchial Tube 120 cm 1.8 mm O.D. (non-sterile)
518-150	Nylon Bronchial Tube 150 cm 1.8 mm O.D. (non-sterile)
518-180	Nylon Bronchial Tube 180 cm 1.8 mm O.D. (non-sterile)
518-240	Nylon Bronchial Tube 240 cm 1.8 mm O.D. (non-sterile)
518-300	Nylon Bronchial Tube 300 cm 1.8 mm O.D. (non-sterile)
793	Nylon Bronchial Tube 120 cm 1.9 mm O.D. (sterile)
192-120	Nylon Bronchial Tube 120 cm 1.9 mm O.D. (non-sterile)

**Custom lengths and different OD/ID also available.**

*continues on next page*

**CAUTION:** This product should be carefully inspected by your staff prior to clinical use and should be used by authorized personnel only.



Part #	Description
192-150	Nylon Bronchial Tube 150 cm 1.9 mm O.D. (non-sterile)
192-180	Nylon Bronchial Tube 180 cm 1.9 mm O.D. (non-sterile)
192-240	Nylon Bronchial Tube 240 cm 1.9 mm O.D. (non-sterile)
192-300	Nylon Bronchial Tube 300 cm 1.9 mm O.D. (non-sterile)
1044	Bronchial Catheter 0.061" in a Pouch
1134	Bronchial Catheter, Clear 0.078" O.D. (1.9 mm) in a Pouch
1153	Bronchial Catheter 0.065" O.D. in a Pouch
1772	0.065" O.D. Bronchial Catheter with Gold Marker & S.S. Ball in a Pouch
1785	0.068" O.D. Bronchial Catheter with Female Luer Lock in a Pouch
1520	Marked Polyacetyl 1.8 mm O.D. Bronchial Catheter in a Pouch
1523	Marked 0.065" O.D. Bronchial Catheter in a Pouch
1465	Marked 0.078" O.D. Bronchial Catheter in a Pouch
1517	Polyacetyl 0.072" O.D. Bronchial Catheter in a Pouch

**!** **CAUTION:** This product should be carefully inspected by your staff prior to clinical use and should be used by authorized personnel only.



## Esophageal Applicator (single tube)

Part # 287-1

**Description:** The Esophageal Applicator is a Nasogastric (NG) tube modified to have one additional afterloading tube in one of the lumens. The afterloading tube is closed at one end and enters through a hole made at 60 cm from the bottom of the NG tube and reaches up to the bottom. A small stainless steel ball is kept at the closed end for checking the position of the tube in the radiograph. A stainless steel button is slid onto the afterloading tube nearer to the open end for suturing to skin.

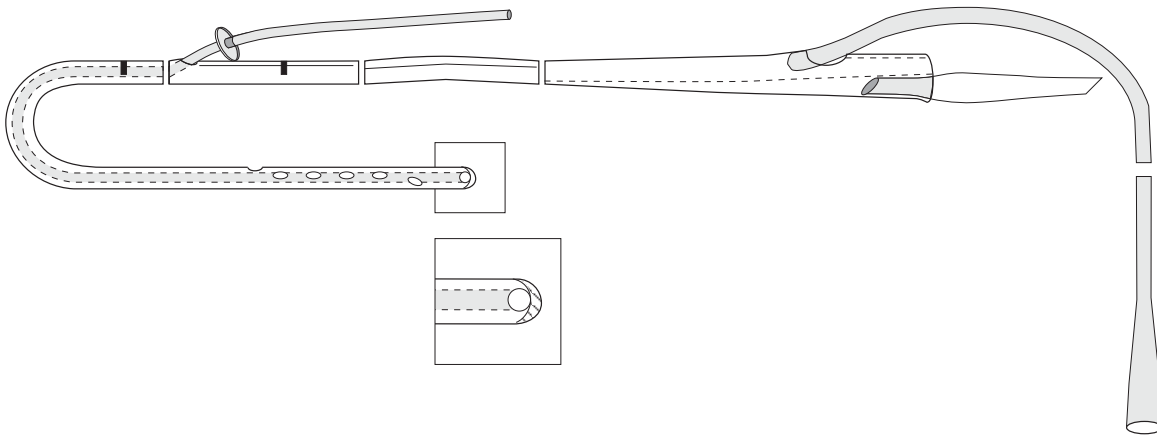

### References:

Intraluminal Radiation for Esophageal Cancer: A Howard University Technique.

Chitti R. Moorthy, J. Rao Nibhanupudy, Ebrahim Ashayeri, Alfred L. Goldson,  
Maria C. Espinoza, Joseph J. Nidiry, Oswald G. Warner and Vincent J. Roux.

“Journal of the National Medical Association, Vol. 74, No. 3, 1982”, Pages 261-266.

**This product is for one time use only.**

**CAUTION:** This product should be carefully inspected by your staff prior to clinical use and should be used by authorized personnel only.



## HDR Remote Afterloading Accessories

### Double Leader Catheter with Filament

#### Part #

542-30	1.7 mm O.D. (non-sterile)
1148	1.7 mm O.D. (sterile)
522-30	1.8 mm O.D. (non-sterile)
186-30	1.9 mm O.D. (non-sterile)
1252	1.9 mm O.D. (sterile)

### Single Leader, Blind End Catheter with Filament

#### Part #

538-30	1.7 mm O.D. (non-sterile)
1146	1.7 mm O.D. (sterile)
564-30	1.8 mm O.D. (non-sterile)
1733	1.8 mm O.D. (sterile)
182-30	1.9 mm O.D. (non-sterile)
1092	1.9 mm O.D. (sterile)

### GB Tech Tube with Button and Filament

#### Part #

616-30	1.7 mm O.D. (non-sterile)
1150	1.7 mm O.D. (sterile)
633-30	1.8 mm O.D. (non-sterile)
1727	1.8 mm O.D. (sterile)
190-30	1.9 mm O.D. (non-sterile)
1105	1.9 mm O.D. (sterile)

**Discription:** The Best Afterloading Catheters are indicated for use in HDR brachytherapy procedures.

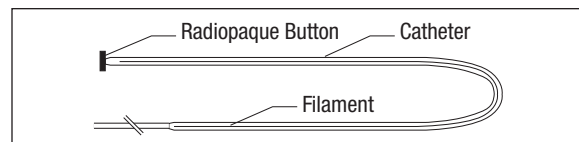
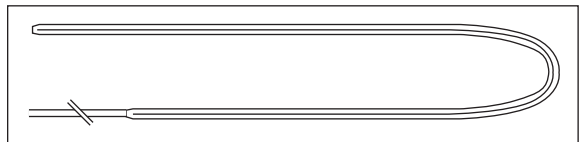
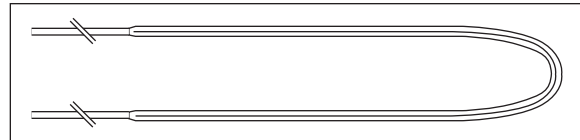

**CAUTION:** This product should be carefully inspected by your staff prior to clinical use and should be used by authorized personnel only.

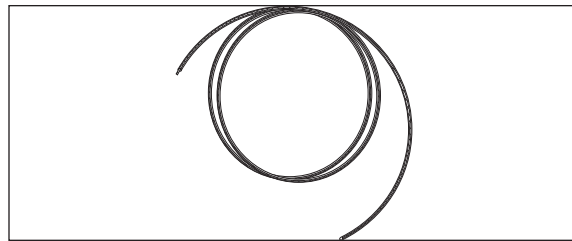
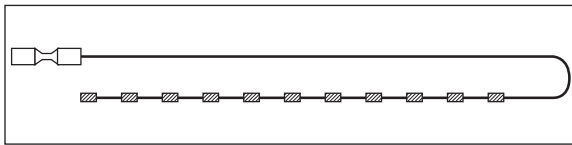
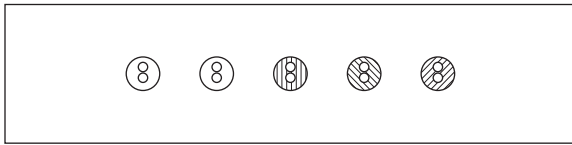

Radiopaque Buttons	
Part #	
244-1	1.7 mm hole
244-2	1.8 mm hole
244-3	1.9 mm hole

X-Ray Catheter (cable dummy ribbon)	
Part #	
530	X-Ray Catheter (cable dummy ribbon)

Nylon Bronchial Catheter	
Part #	
191	1.7 mm O.D. (non-sterile)
791	1.7 mm O.D. (sterile)
518	1.8 mm O.D. (non-sterile)
1082	1.8 mm O.D. (sterile)
192	1.9 mm O.D. (non-sterile)
793	1.9 mm O.D. (sterile)

All catheters are available in custom lengths, with or without cable/cable dummy ribbon.



**CAUTION:** This product should be carefully inspected by your staff prior to clinical use and should be used by authorized personnel only.



# Best<sup>®</sup> medical international

## Applicators

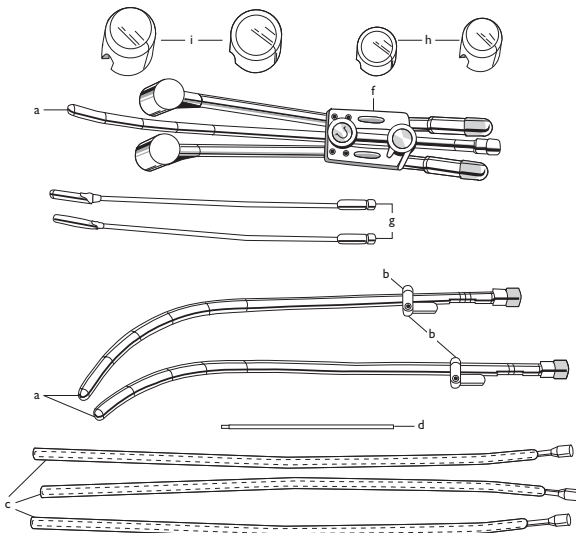
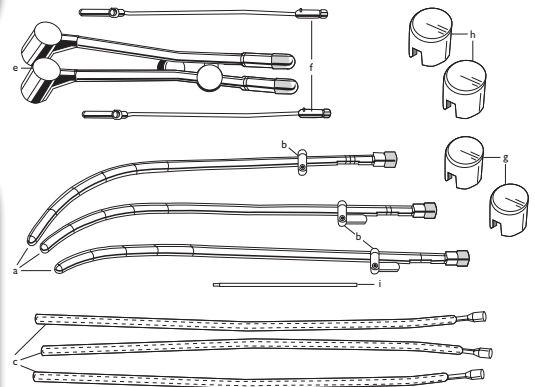
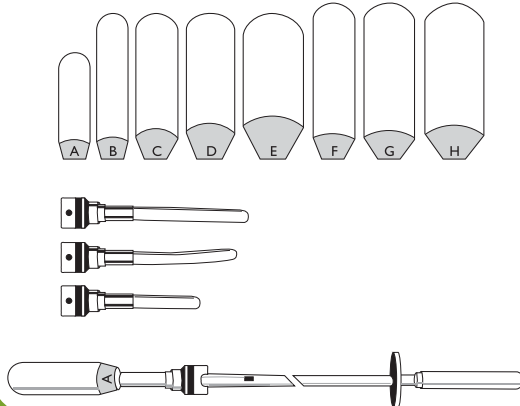
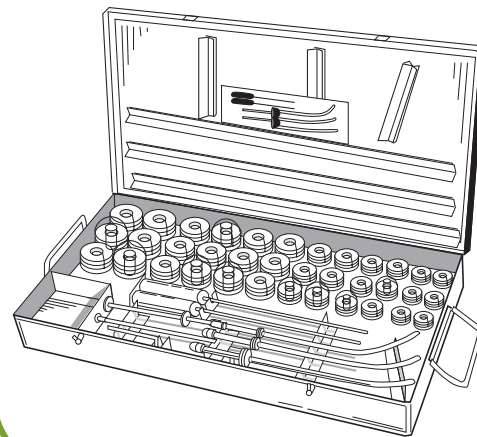
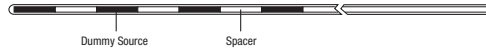
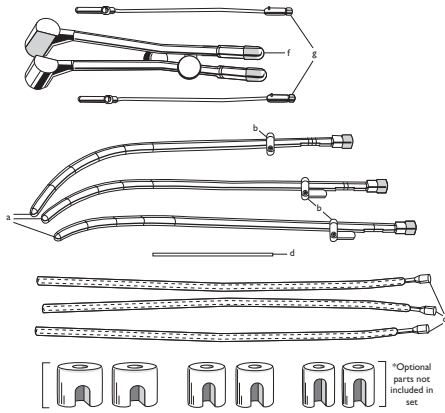

## Round-Handle Fletcher-Suit-Delclos Applicator Set (640R)

Part # 5005-0082

### Set Contains:

3	(a) Central Tandems
3	(b) Cervical Stops (1 with flag, 2 without flag)
3	(c) Plastic Tandems and Pushers
1	(d) Storage/Sterilization Tray (not shown)
1	(e) Pair Colpostat w
2	(f) Bucket Type Source Carriers
1	(g) Pair Nylon Caps 2.5 cm Diameter for Ovoids
1	(h) Pair Nylon Caps 3.0 cm Diameter for Ovoids
1	(i) Allen Wrench

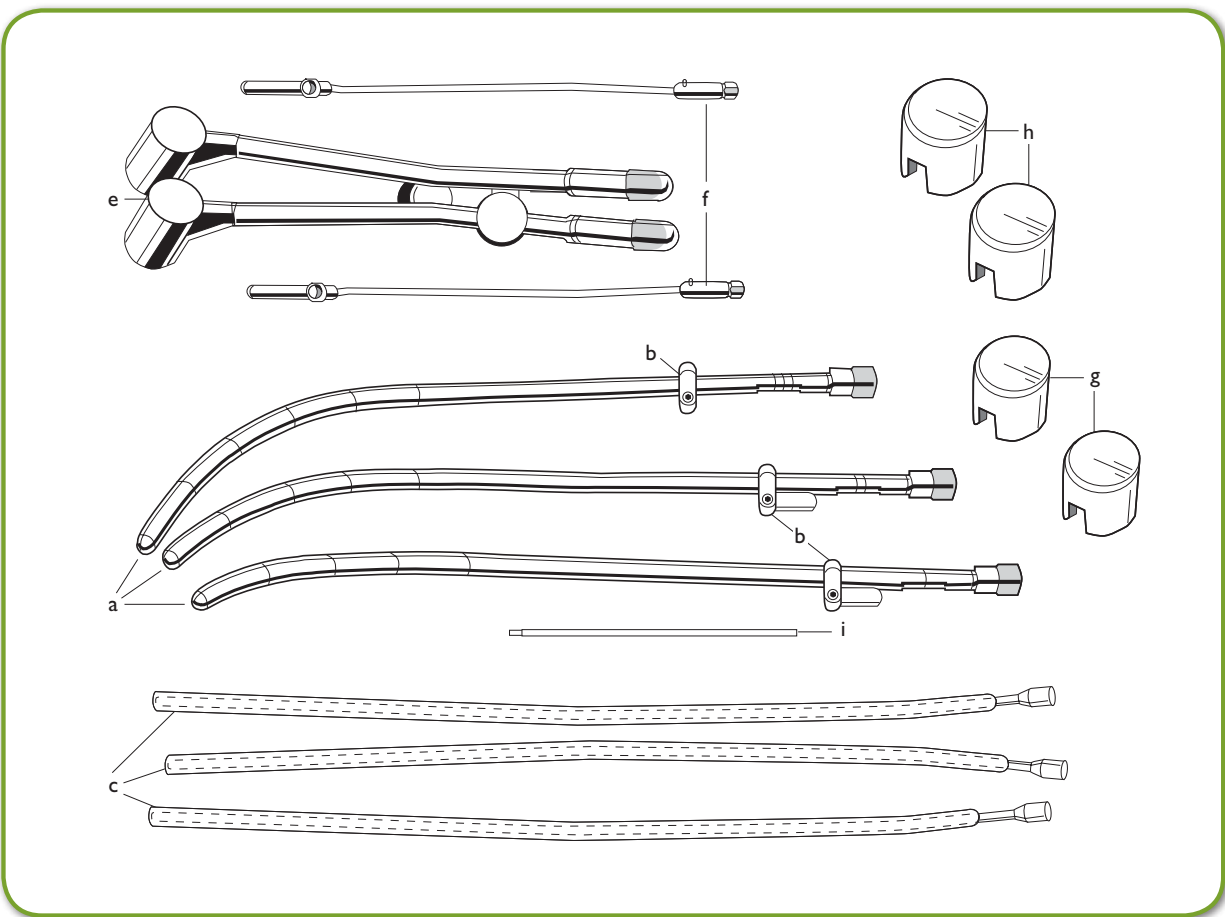

**CAUTION:** This product should be carefully inspected by your staff prior to clinical use and should be used by authorized personnel only.

## Round Handle Fletcher-Suit-Delclos Applicator Set with Bracket (640RB)

Part # 5005-0083

### Set Contains:

3	(a) Central Tandems
3	(b) Cervical Stops (1 with flag, 2 without flag)
3	(c) Plastic Tandems and Pushers
2	(d) Allen Wrenches
1	(e) Storage/Sterilization Tray (not shown)
1	(f) Pair Colpostat with Bracket (to hold central tandem along with colpostat and also to separate the ovoids)
1	(g) Pair Bucket Type Source Carriers
1	(h) Pair Nylon Caps 2.5 cm Diameter for Ovoids
1	(i) Pair Nylon Caps 3.0 cm Diameter for Ovoids

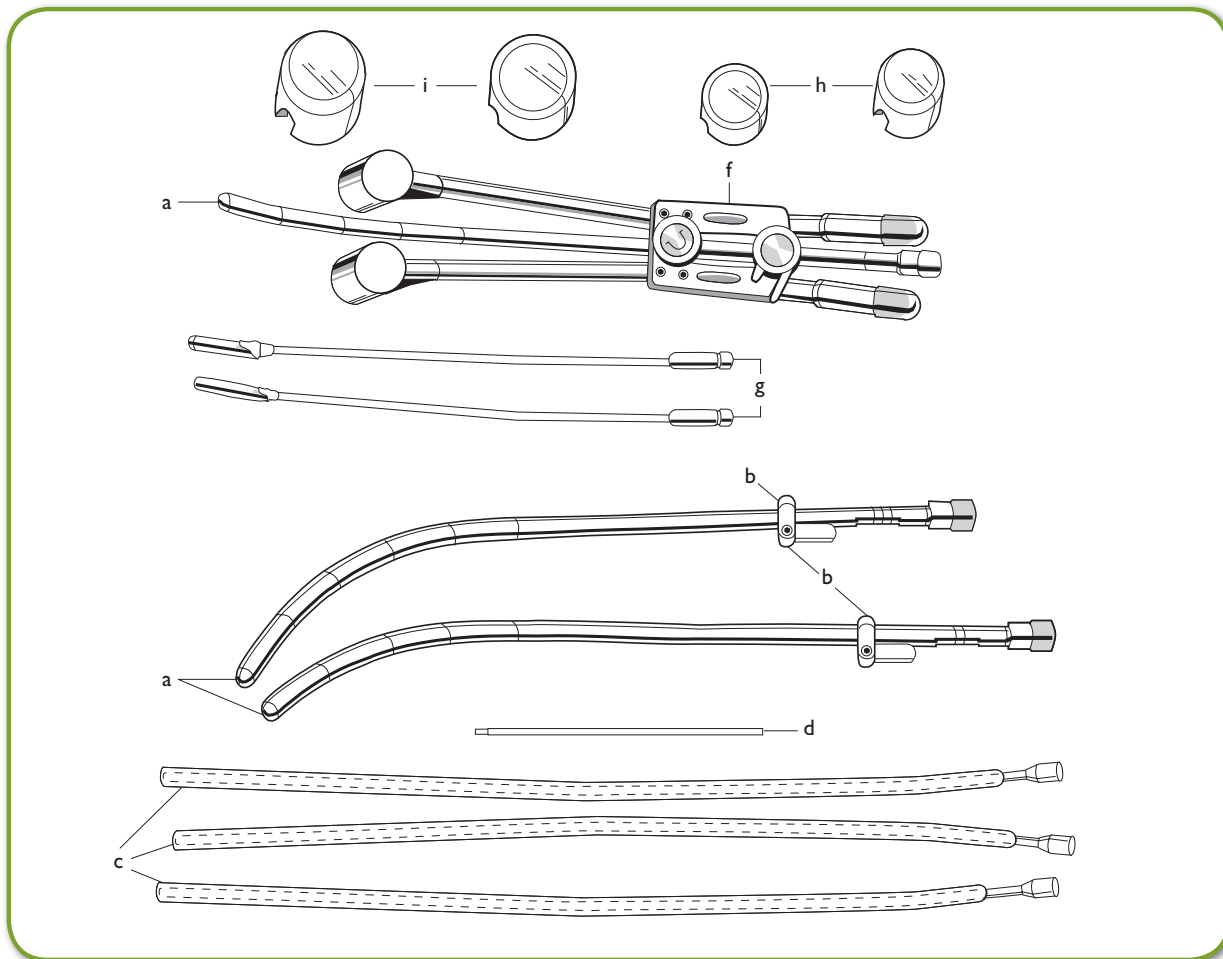

**CAUTION:** This product should be carefully inspected by your staff prior to clinical use and should be used by authorized personnel only.

## Fletcher-Suit-Delclos Mini-Ovoid Applicator Set (640M)

Part # 5005-0084

### Set Contains:

3	(a) Central Tandems
3	(b) Cervical Stops (1 with flag, 2 without flag)
3	(c) Plastic Tandems and Pushers
1	(d) Allen Wrench
1	(e) Storage/Sterilization Tray (not shown)
1	(f) Pair Colpostat
2	(g) Bucket Type Source Carriers

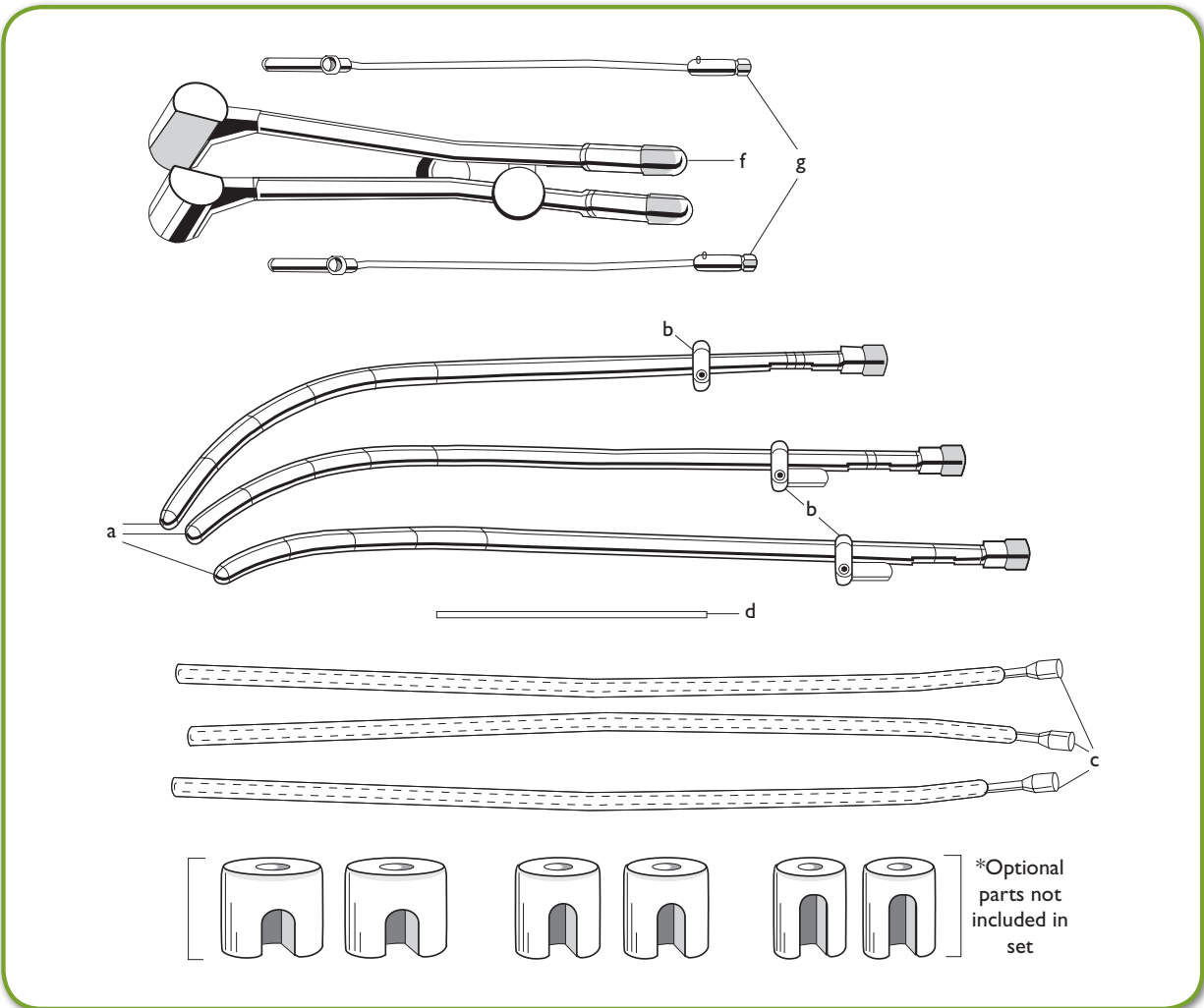

\* **Optional: Shielded Caps 2 cm, 2.5 cm, 3 cm Diameters.**



**CAUTION:** This product should be carefully inspected by your staff prior to clinical use and should be used by authorized personnel only.



## Delclos Mini-Ovoid Applicator Set with Bracket Assembly (640MRB)

Part # 5005-0085

### Set Contains:

3	(a) Central Tandems
3	(b) Cervical Stops (1 with flag, 2 without flag)
3	(c) Plastic Tandems and Pushers
2	(d) Allen Wrenches
1	(e) Storage/Sterilization Tray (not shown)
1	(f) Pair Colpostat with Bracket
2	(g) Bucket Type Source Carriers

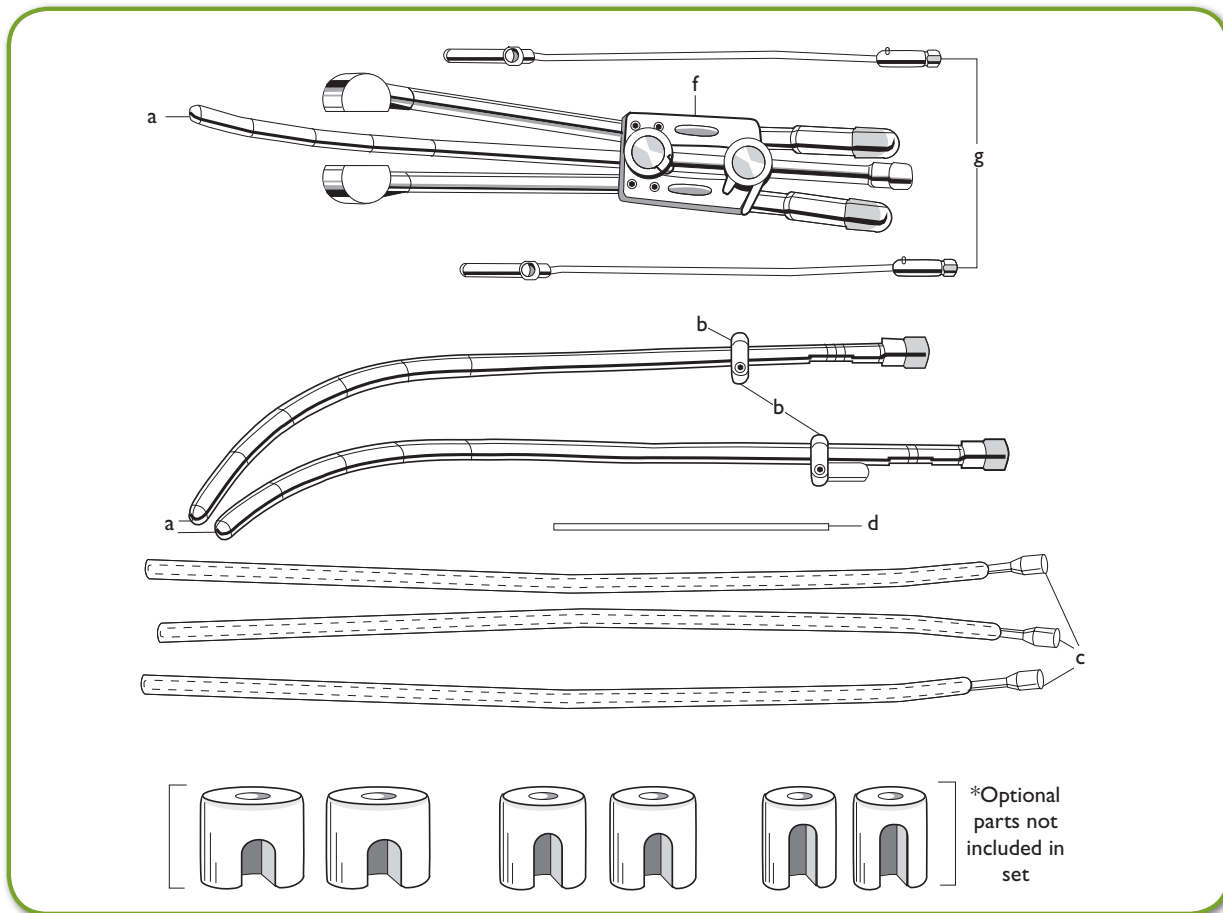

**\* Optional: Shielded Caps 2 cm, 2.5 cm, 3 cm Diameters.**

**CAUTION:** This product should be carefully inspected by your staff prior to clinical use and should be used by authorized personnel only.



## Burnett Afterload Vaginal Applicator (700A)

Part # 5005-0088

### Set Contains:

8	Cylon Cylinders
4	Plastic tandems with metal screws and special long handle (cap holder) and tube source adapter assembly arranged in a stainless steel tray.

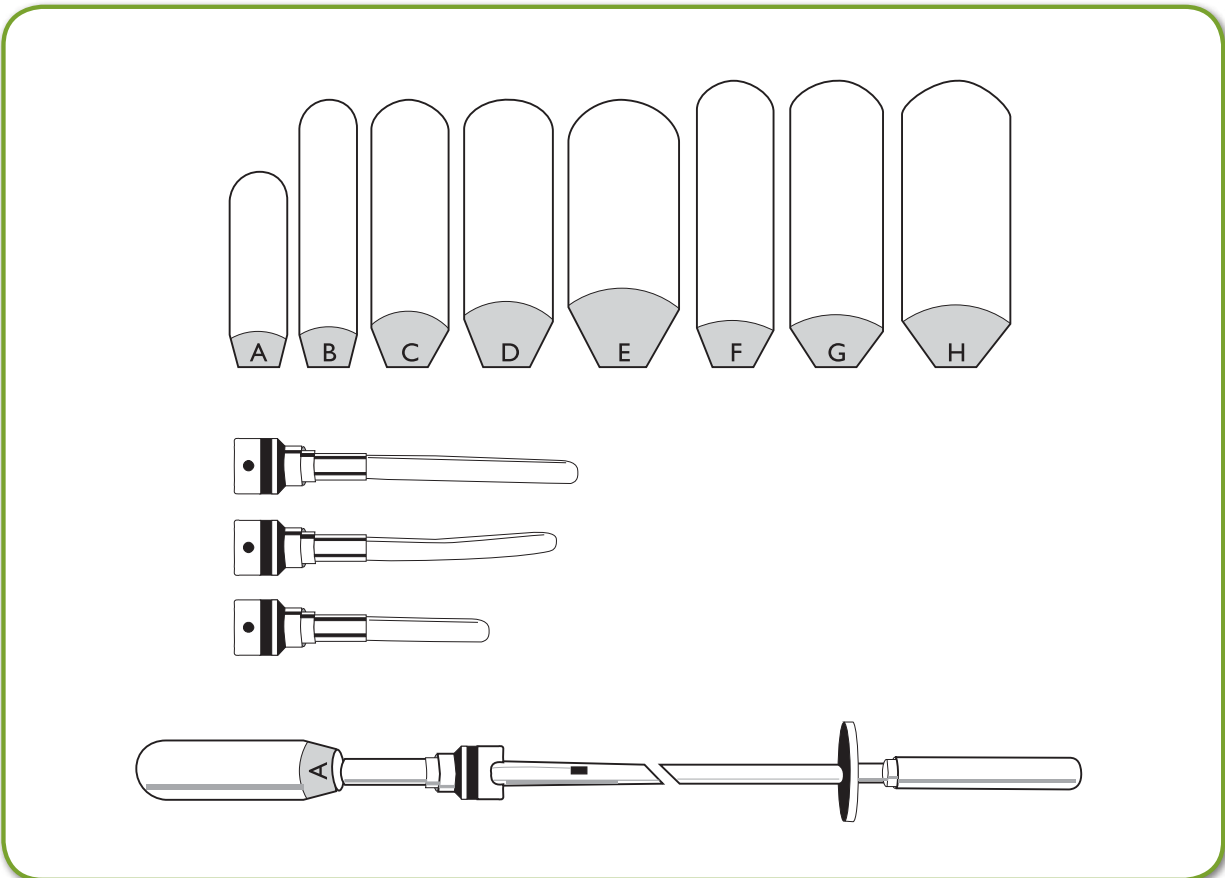

### External Dimensions of Cylinders:

A	20 x 66 mm
B	20 x 87 mm
C	25 x 87 mm
D	30 x 87 mm
E	35 x 87 mm
F	25 x 95 mm
G	30 x 95 mm
H	35 x 95 mm

**CAUTION:** This product should be carefully inspected by your staff prior to clinical use and should be used by authorized personnel only.

## Delclos Uterine/Vaginal Afterloading Applicator and Dome Assembly (670)

Part # 5005-0089

### Set Contains:

6	Sets of Cylinders with Diameters 20 mm, 25 mm, 30 mm, 35 mm, 40 mm and 45 mm
6	Domes (matching cylinder diameters)
3	Uterine Tandems
1	Vaginal Tandem (dome assembly)
1	Vaginal Tandem (with a flat end)
1	Storage/Sterilization Tray
1	Standard Allen Wrench
1	Extended Allen Wrench
1	Cylinder Extractor
1	Cervical Stop
4	Plastic Tandems and Pushers

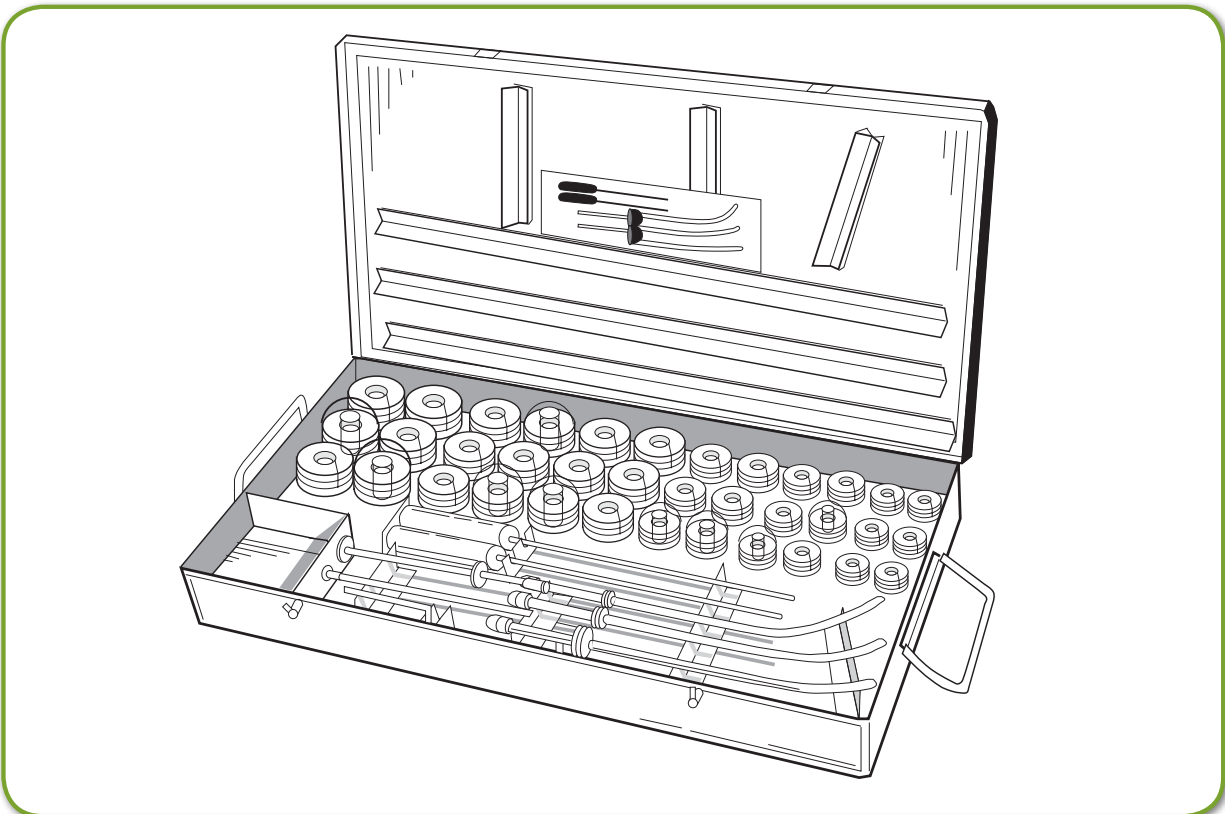

**CAUTION:** This product should be carefully inspected by your staff prior to clinical use and should be used by authorized personnel only.

## Dummy Sources (Cesium)

### Part # 513-1

These are Dummy Tungsten Sources with a length of 20 mm and a diameter of 3 mm to simulate Cesium sources, arranged with 20 mm long spacers in a plastic tube so as to load conveniently in a central tandem. Because of the high density of Tungsten a better Radiograph is obtained. Custom arrangements of these sources are available.

### Four (4) Cesium Dummy Sources Arranged in a Plastic Tube

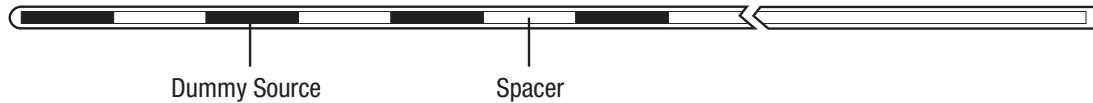

## Dummy Sources (Cesium)

### Part # 513-2

Instead of total length of 20 mm, active length of 14 mm also could be used for loading in plastic tube. Custom arrangements of these are available.

### Also Available:

513	Cesium Dummy Sources for 3M Sources
696	Cesium Dummy Sources for Amersham Sources

### Other Custom Loadings Available



**CAUTION:** This product should be carefully inspected by your staff prior to clinical use and should be used by authorized personnel only.

<b>Mick<sup>®</sup> 200-TPV Applicator Kit</b>		
<b>Part # 5005-9707</b>		
<b>Set Includes:</b>		<b>Part #</b>
1 ea.	Mick 200-TPV Applicator (instrument only)	5005-9701-1
1 ea.	8x Mick TP Needles, 17 or 18 Gauge "Authentic" (carton)	10203-25 (17G) or 10209-25 (18G)
1 ea.	Diddler (needle adjustment tool)	5002-0010
1 ea.	Seed Loading V-Block with Seed Gauge	5005-7509
1 ea.	Pushwire Rod Assembly (spare)	5005-9707-PW
2 ea.	Reverse Action Tweezer	5002-0009
1 ea.	Loop Wire, 22 cm (needle cleaning device)	5005-7702
1 ea.	Stainless Steel Screwdriver/Allen Wrench Combo	5005-7311-C
1 ea.	Sterilization & Storage Cassette	5005-0505
1 ea.	Instruction Manual	405-06

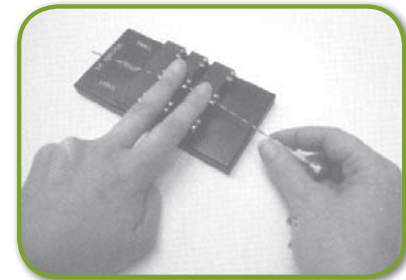
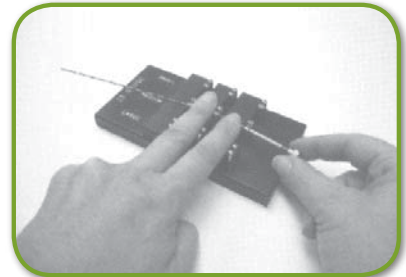
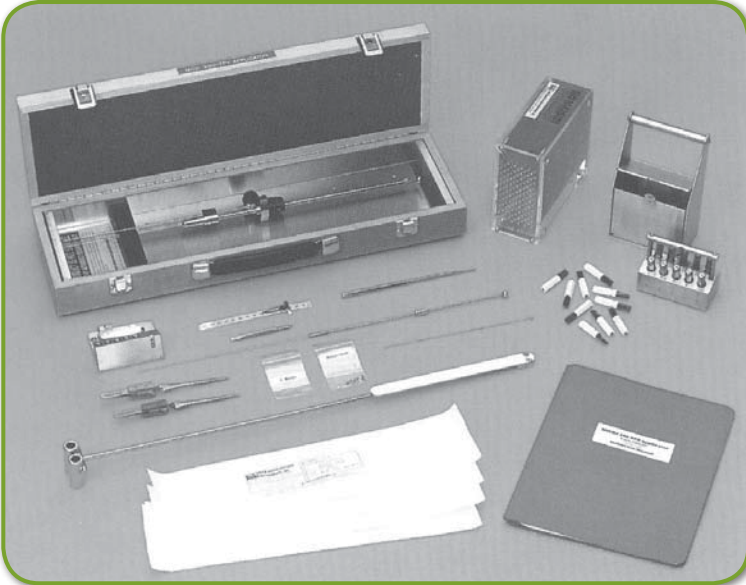

### Steerable "Authentic" Mick TP Needles!

Circumvent pubic arch interference with the use of the Mick Needle Former.

## Ordering Information: Optional Instrumentation and Accessories

### Part # 5005-9707

Product:	Part #
Reverse Action Tweezer	5002-0009
Diddler (needle adjustment tool)	5002-0010
Transperineal Template – Transparent, 17 Gauge	5005-8813-17
Transperineal Template – Transparent, 18 Gauge	5005-8813-18
Mick Needle Former (steerable Mick needles)	5005-0226
V-Block (cartridge seed-loading device)	5005-7509
Stainless Steel Sterilization Tray with Instrument Holder	5005-7308-STI
Wooden Carrying Case	5005-7611
Morgenstern, Stabilizing Needle, 18 Gauge	10207
Practice Phantom with 100 Dummy Seeds	5005-8113-PIP
KGM Passer (radiation shielding device)	5005-9512
Inspector (radiation survey meter)	5005-963ERAD
Springs (for magazines)	5005-9609-SP
E-Rings (for magazines)	5005-9609-E
Prostate Phantom, CIRS	5005-9603-53
Mick Magazine, Reusable (10 seed capacity)	5005-7609
Mick Magazine, Disposable (15 seed capacity)	10113-7
Mick TP Needle, 18 Gauge “Authentic”	10209-25
Mick TP Needle, 17 Gauge “Authentic”	10203-25
Pushwire Rod Assembly (Mick 200-TPV applicator)	5005-9707-PRA
Stainless Steel Allen Wrench/Screwdriver (combination)	5005-7311-C
Brachystand 6 Ultra for Use with E&K or Siemens Stepper	5005-1000
Sure-Point I (floor mount with Siemens stepper)	5005-FMS
Sure-Point II (table mount with Siemens stepper)	5005-UTMS
Disposable Templates, B&K	1830
Leaded Gloves – Radiation Attenuation Gloves	5005-5327005
Ultrasonic Cleaner with Timer and Heater	5005-7908-10TH
Stainless Steel Dummy Seeds	5005-8212-DS

**CAUTION:** This product should be carefully inspected by your staff prior to clinical use and should be used by authorized personnel only.



# Best<sup>®</sup> medical international

## Brachytherapy Kits

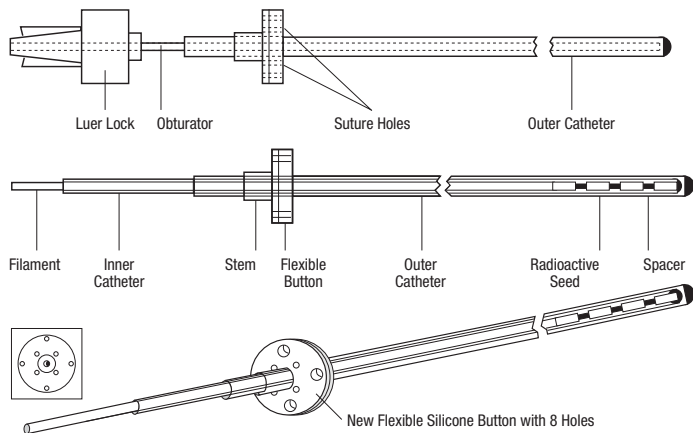

## Interstitial Implant Instrument Set

*Part # 1074-0012 (cable dummy ribbon) &  
Part # 1074-0013 (nylon dummy ribbon)*

### Set Contains:

1	Crile Needle Holder for Crimping Buttons
1	M.G.H. Needle Holder, 10 inch
1	Curved Scissors, 10 inch
1	Special Cutter for Nylon Implant Tubes
10	Implant Needles, 10 cm Long, 17 Gauge
10	Implant Needles, 15 cm Long, 17 Gauge
10	Implant Needles, 20 cm Long, 17 Gauge
10	Implant Needles, 25 cm Long, 17 Gauge
5	Implant Needles, 10 cm Long, 14 Gauge
5	Implant Needles, 15 cm Long, 14 Gauge
5	Implant Needles, 20 cm Long, 14 Gauge
1	Iridium Funnel
30	Nylon Retaining Buttons (Syed)
30	Stainless Steel Retaining Buttons (Henschke)
15	Dummy Ribbons with 12 Seeds Each (specify cable or nylon dummy)
20	Nylon Implant Tubes (double leader)
3	Stylets
1	Quick-charge Sealer



## The Best<sup>®</sup> Brachytherapy Kit

### Sterile

#### Consists of:

5	6.0 FR-30 or 5.0 FR-30 cm Afterloading Single Leader Catheters with Filaments and Buttons
5	Radiopaque or Clear Nylon Half Moon Buttons
5	17 Gauge or 16 Gauge 20 cm Implant Needles
5	Obturators
5	Friction Cups
5	Red Caps

The catheter tubes are available in four colors (clear, blue, green or purple) and with either radiopaque or clear nylon buttons.





## Sterile Brachytherapy Kits

*Most Brachytherapy kits are available in four different colors.*

Part #	Description
829	HDR Brachytherapy Kit with Radiopaque Button and 17 Gauge Needles
848	LDR Brachytherapy Kit with Nylon Button and 17 Gauge Needles
856	LDR Brachytherapy Kit with Radiopaque Button and 17 Gauge Needles
862	HDR Brachytherapy Kit with Nylon Button and 17 Gauge Needles
867	HDR Brachytherapy Kit with Radiopaque Button and 16 Gauge Needles
868	LDR Brachytherapy Kit with Nylon Button and 16 Gauge Needles
870	LDR Brachytherapy Kit with Radiopaque Button and 16 Gauge Needles
872	HDR Brachytherapy Kit with Nylon Button and 16 Gauge Needles
876	HDR Brachytherapy Kit without Printing with Radiopaque Button and 17 Gauge Needles
880	LDR Brachytherapy Kit without Printing with Nylon Button and 17 Gauge Needles
884	LDR Brachytherapy Kit without Printing with Radiopaque Button and 17 Gauge Needles
888	HDR Brachytherapy Kit without Printing with Nylon Button and 17 Gauge Needles
890	HDR Brachytherapy Kit without Printing with Radiopaque Button and 16 Gauge Needles
892	LDR Brachytherapy Kit without Printing with Nylon Button and 16 Gauge Needles
894	HDR Brachytherapy Kit without Printing with Nylon Button and 16 Gauge Needles
896	LDR Brachytherapy Kit without Printing with Radiopaque Button and 16 Gauge Needles
1202	Polyacetal Brachytherapy Kit
1283	HDR Brachytherapy Kit with Blind End Catheters
1363	Brachytherapy Kit with Radiopaque Buttons, Catheters without Filament
1366	Brachytherapy Kit with Nylon Buttons, Catheters without Filament
1401	Brachytherapy Kit with Radiopaque Buttons and Markings (catheters without filament)
1404	Brachytherapy Kit with Nylon Buttons and Markings (catheters without filaments)
1421	Polyacetal Brachytherapy Kit, Catheter Leaders with Cable and Nylon Buttons

*continues on next page*



<b>Sterile Brachytherapy Kits (continued)</b>	
<i>Most Brachytherapy kits are available in four different colors.</i>	
<b>Part #</b>	<b>Description</b>
1424	Polyacetal Brachytherapy Kit, Catheter Leaders with Cable and Radiopaque Buttons
1470	13 Gauge Brachytherapy Kit
1480	1.9 mm PA Brachytherapy Kit with Nylon Buttons
1484	1.9 mm PA Brachytherapy Kit with Nylon Buttons and Markings
1487	1.9 mm PA Brachytherapy Kit with Radiopaque Buttons and Markings
1627	HDR Brachytherapy Kit with Blind End Catheters and Nylon Buttons
1630	LDR Blind End Brachytherapy Kit with Nylon Buttons
1632	LDR Blind End Brachytherapy Kit with Radiopaque Buttons
1667	50 cm Brachytherapy Kit with Markings and Nylon Buttons
1702	1.9 mm Polyacetal Brachytherapy Kit with Nylon Buttons and 16 Gauge Needles
1704	1.9 mm Polyacetal Brachytherapy Kit with Radiopaque Buttons and 16 Gauge Needles
1731	Brachytherapy Kit with XX cm Blind End Catheters Radiopaque Buttons

**\*\* please specify length**

## Implant Kit

Part # 289-1; Sterile Kit Part # 1502

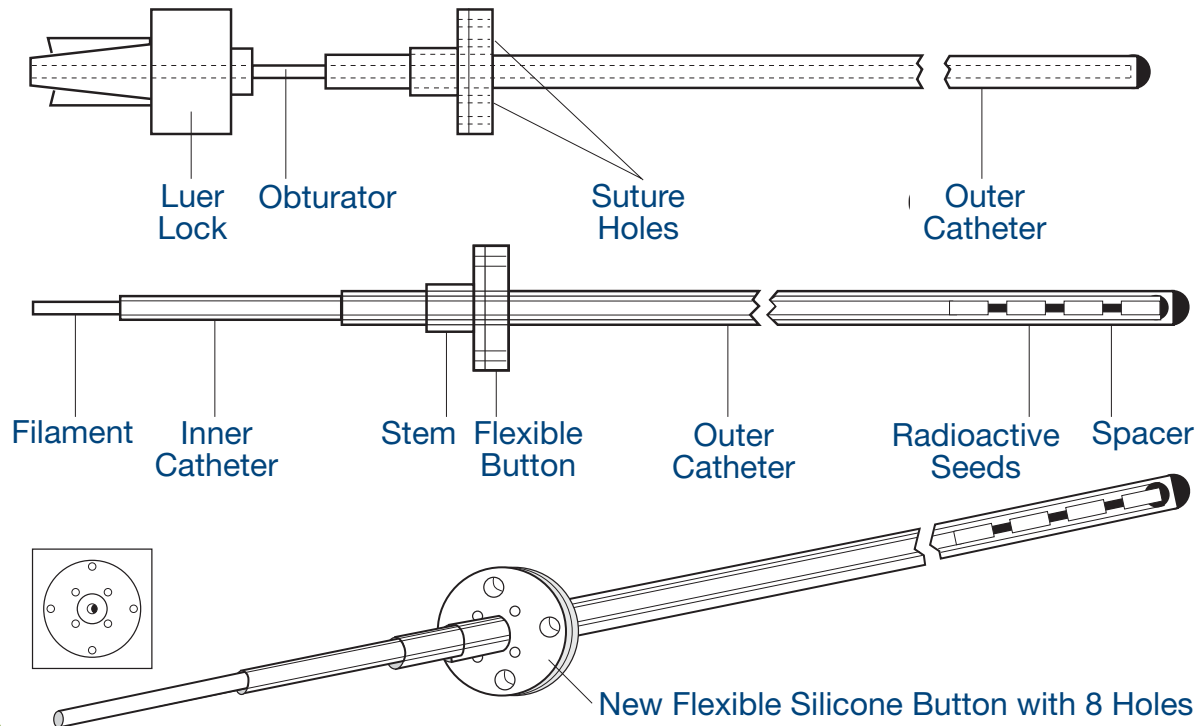

The Implant Kit consists of an outer catheter made of celcon and an inner catheter made of nylon with a nylon filament. The outer catheter has a standard length of 25 cm (other lengths available) with a special obturator and flexible button, closed smoothly on one end. The O.D. of the outer catheter is approximately 0.080" and the I.D. is 0.057". The inner catheter has a standard length of 26 cm (other lengths available) with O.D. of approximately 0.052" and I.D. of 0.038". It is designed for use with standard Iridium-192 and Iodine-125 sources. The filament can be used as spacers and can be heat sealed. The buttons can be positioned along the outer catheter using the appropriate glue. They have suture holes and the stem can be crimped or heat sealed. Each kit is supplied with 3 buttons: flexible large, flexible small, and stainless steel.

Part #	
300-1	Flexible Button (large)
238-3	Stainless Steel Button
301-1	Flexible Button (small)

**This product is for one time use only.**

**CAUTION:** This product should be carefully inspected by your staff prior to clinical use and should be used by authorized personnel only.



# Best<sup>®</sup> medical *international*

## Brachytherapy Needles

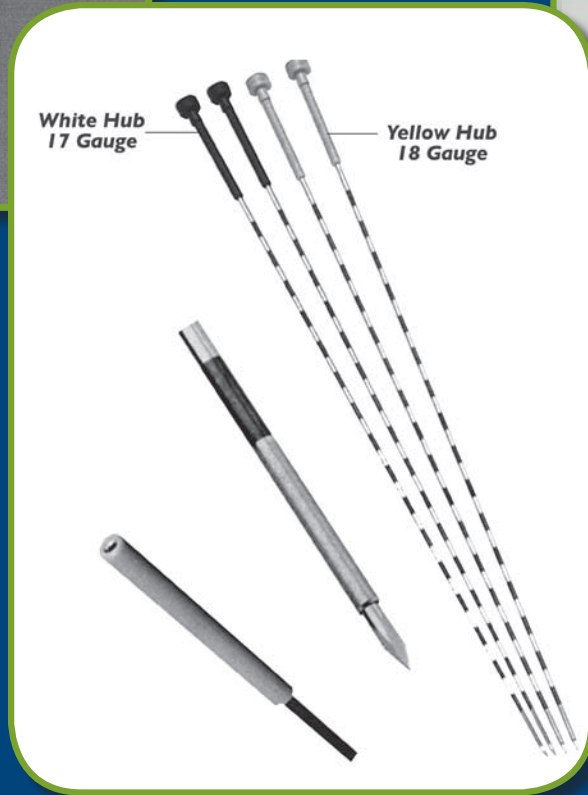
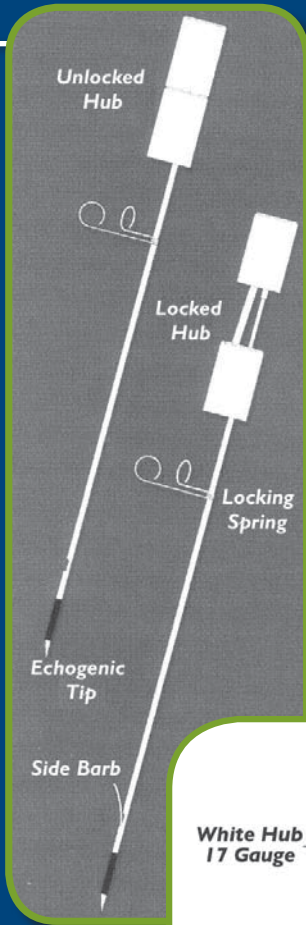

White Hub  
17 Gauge

Yellow Hub  
18 Gauge

The Mick type needle's obturator is provided with a sharp trocar point while the echogenic canula tip is ground-beveled to facilitate the penetration of the skin.

The Mick type needle's hub canula is "honed" for smooth transfer of seeds from the applicator into and through the needle.

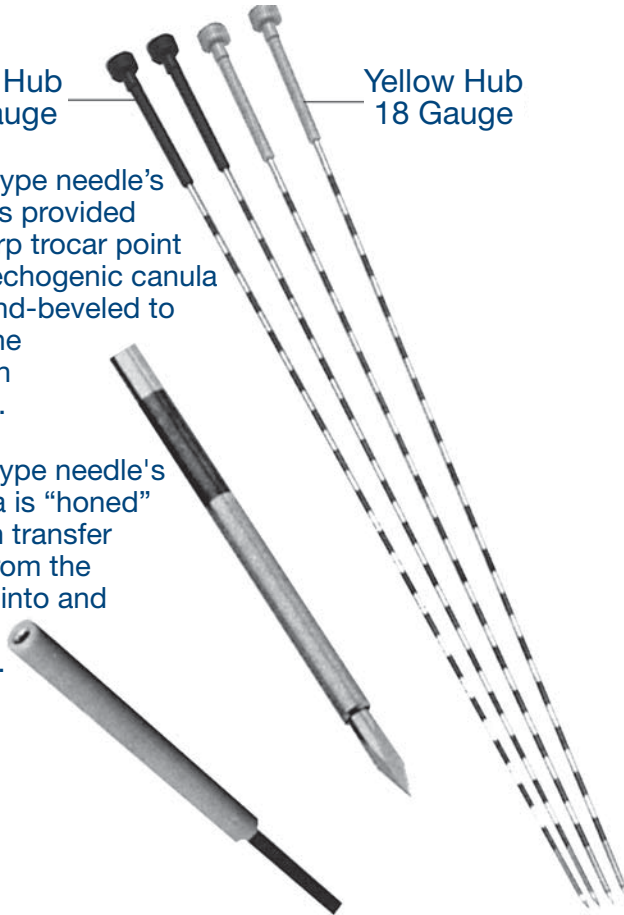

### Best Mick Type Needles

Part #	
10203	17 Gauge White Hub
10209	18 Gauge Yellow Hub

### Best Mick Type Needles

- Sterile/disposable
- Mirror finish stylet
- Siliconized/calibrated
- Flared canula hub
- Improved sharpness
- Color coded hubs
- Trocar point
- Available 17 and 18 gauge
- Rigid stylet
- Echogenic bevel

### Packaged, Sterile and Disposable

- 25 Needles per carton
- 4 Pouches with 5 needles
- 5 Pouches with 1 needle

### Specifications (For Single Use Only)



## Best Prostate Seeding Needles

Best Prostate Seeding Needles	
Part #	
10215	Best C.P. Type Round Hub Needles
10201	Best C.P. Type Square Hub Needles
10197	Best Square Hub Needles
10199	Best Round Hub Needles

### Best Prostate Seeding Needles

- Sterile/disposable
- Low price
- Echogenic bevel
- Siliconized
- Calibrated stylet
- Improved sharpness
- Bevel point
- Available 17 and 18 Gauge

### Packaged, Sterile and Disposable

- 25 Needles per carton
- 5 Pouches with 1 needle
- 4 Pouches with 5 needles each

### Specifications (For Single Use Only)

“A” and “B” bevel needles are available.



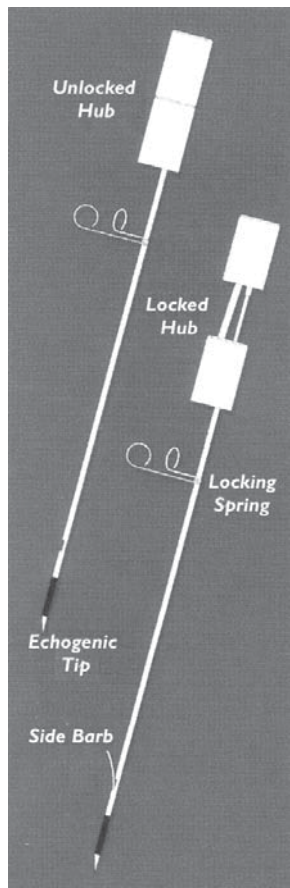

## Prostate Stabilization Set Needles

### Part #

10207

18 Gauge x 20 cm  
Sterile;  
2 Needles per Set

Improved Seed Distribution by Means of Prostate Gland Immobilization

### Prostate Stabilization Set

The Stabilizing Needle (patented) is designed to prevent prostate movement during the insertion of prostate seeding needles. Immobilization is accomplished by deployment of a “side barb” in the prostate tissue and then securing a “lock spring” against the proximal side of the template. Two stabilizing needles must be used to adequately stabilize the prostate gland.

### Features

- Two-part hub design
- Locking side barb
- Sharp bevel-point needle tip
- Echogenic tip
- Sterile pouch contains 2 needles

### Packaged:

18 Gauge x 20 cm sterile;  
2 needles per set



Needles	
Part #	
10171	Brachytherapy Needles Round Hub 18 Gauge x 10 cm with Wax in a Pouch
10180	Brachytherapy Needles Square Hub 18 Gauge x 20 cm with Wax in a Pouch
10183	Brachytherapy Needles Square Hub 17 Gauge x 20 cm without Wax in a Pouch
10222	Brachytherapy Needles Square Hub 17 Gauge x 20 cm with Wax in a Pouch
10191	Brachytherapy Needles Round Hub 18 Gauge x 20 cm with Wax in a Pouch
10195	Best Applicator Needles with "B" Bevel Blunt Stylet in a Pouch
10207	Prostate Stabilizing Needles 18 Gauge x 20 cm in a Pouch
10211	Brachytherapy Needles Round Hub 18 Gauge x 20 cm Pink Stylet with Wax in a Pouch
10213	Brachytherapy Needles Square Hub 18 Gauge x 20 cm Pink Stylet with Wax in a Pouch
10220	Brachytherapy Needles Round Hub 18 Gauge x 30 cm with Wax in a Pouch
10221	Brachytherapy Needles Round Hub 18 Gauge x 30 cm without Wax in a Pouch
10224	Needles Round Hub 16 Gauge x 20 cm without Wax (sterile)
10226	Needles Square Hub "B" Bevel 18 Gauge x 20 cm with Wax (sterile)
10229	Needles Round Hub "B" Bevel 18 Gauge x 20 cm with Wax (sterile)
10232	Brachytherapy Needle Metal Hub Zebra 18 Gauge x 20 cm
10211	Needles Square Hub 18 Gauge x 20 cm with Pink Stylet without Wax
5006-0033	18 Gauge x 20 cm Long Best Custom Stylet Applicator Needle (dittoli type)





# Best<sup>®</sup> medical *international*

## Dummy Ribbons



## Anderson Forell Suthanthiran Nylon Dummy Ribbon Set

Part # 5006-0003

### Set Contains:

One Ribbon with 12 Seeds each of 1.2 mm Length

One Ribbon with 12 Seeds each of 1.8 mm Length

One Ribbon with 12 Seeds each of 2.4 mm Length

One Ribbon with 12 Seeds each of 3.0 mm Length

One Ribbon with 12 Seeds each of 4.0 mm Length

This enables identification of ribbons in complex implants, facilitates implant radiography and improves localization accuracy. Dr. Lowell L. Anderson of Memorial Sloan-Kettering Cancer Center and Mr. Bruce Forell of City of Hope Medical Center have been very instrumental in bringing about this design concept.

## Nylon Dummy Ribbon

Part # 220

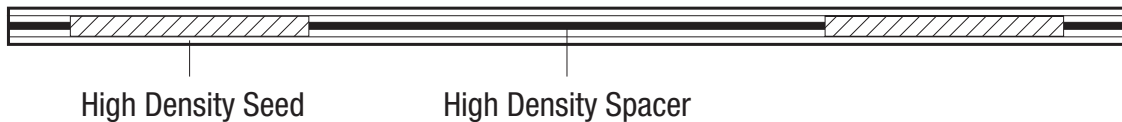

The diameter of the Nylon Dummy Ribbon and High Density Seed are 0.85 mm and 0.5 mm respectively. Nylon Dummy Ribbons are also available with seed lengths of 0.6 mm, 1.2 mm, 1.8 mm, 2.4 mm, 3.0 mm, 4.0 mm and 5.0 mm.

## Cable Dummy Ribbon

Part # 423/HDR Part # 530



Cable Dummy Ribbons are similar to the Nylon Dummy Ribbons. The diameters of the cable and the dummy seeds are 0.5 mm and 0.85 mm respectively. Custom made Cable Dummy Ribbons are available with or without alternate markers using seed lengths of 0.6 mm, 1.2 mm, 1.8 mm, 2.4 mm and 3.0 mm.

**CAUTION:** This product should be carefully inspected by your staff prior to clinical use and should be used by authorized personnel only.

# Best<sup>®</sup> medical *international*

## Flexi-Needles



## Flexi-Needles



### Description

Flexi-Needles are sharp or blunt, with closed-ended needle guides, and have a nominal 0.3 cm long tip. They are made of biologically compatible material. (Custom lengths are available upon request.)

### Intended Use

Flexi-Needles are inserted transcutaneously, using special obturators. They are designed to be afterloaded with Iridium-192 or Iodine-125 ribbon sources. Two types of caps are available (Luer Cap or Slip Cap) to place over the loaded Flexi-Needle to hold the ribbons in place during irradiation. Simulator sources can be used for localization; obturators are left in place until the time each is afterloaded with the appropriate radioactive source.

### PRECAUTIONS

- CAUTION:** Device is shipped Non-Sterile or Sterile.
- CAUTION:** Flexi-Needles and Obturators are for single use only.
- CAUTION:** Federal law restricts this device to sale by or on the order of a physician.
- CAUTION:** Ensure Obturator is all the way to the tip of the Flexi-Needle prior to insertion.
- CAUTION:** Luer hubs may separate from the Flexi-Needle and Obturators if excessive force is applied.

**WARNING:** Obturators are made of Tungsten or Stainless Steel. Both obturator and Flexi-Needle may break if bone, hard skin, hard surfaces, or excessive forces are encountered.

Flexi-Needle Combinations			
Gauge	Part #	Outer Diameter	Inner Diameter
<b>1. Flexi-Needle Sharp without Luer Lock, without Obturator**</b>			
13 Gauge	251-**	0.095"	0.078"
14 Gauge	252-**	0.083"	0.062"
15 Gauge	253-**	0.078"	0.057"
15.5 Gauge	491-**	0.072"	0.054"
16 Gauge	254-**	0.066"	0.050"
17 Gauge	255-**	0.058"	0.040"
18 Gauge	256-**	0.050"	0.031"
<b>2. Flexi-Needle Sharp, with Luer Lock, without Obturator**</b>			
13 Gauge	263-**	0.095"	0.078"
14 Gauge	264-**	0.083"	0.062"
15 Gauge	265-**	0.078"	0.057"
15.5 Gauge	554-**	0.072"	0.054"
16 Gauge	266-**	0.066"	0.050"
17 Gauge	267-**	0.058"	0.040"
18 Gauge	268-**	0.050"	0.031"
<b>3. Flexi-Needle Sharp, with Luer Lock and Tungsten Obturator**</b>			
14 Gauge	282-**	0.083"	0.062"
15 Gauge	283-**	0.078"	0.057"
15.5 Gauge	555-**	0.072"	0.054"
16 Gauge	284-**	0.066"	0.050"
17 Gauge	285-**	0.058"	0.040"
18 Gauge	286-**	0.050"	0.031"
<b>4. Flexi-Needle Sharp, with Luer Lock and Stainless Steel Obturator**</b>			
13 Gauge	281-**	0.095"	0.078"
14 Gauge	755-**	0.083"	0.062"
15 Gauge	733-**	0.078"	0.057"
15.5 Gauge	1568-**	0.072"	0.054"
16 Gauge	749-**	0.066"	0.050"
17 Gauge	741-**	0.058"	0.040"
18 Gauge	763-**	0.050"	0.031"

**\*\* please specify length**

*continues on next page*

<i>Gauge</i>	<i>Part #</i>	<i>Outer Diameter</i>	<i>Inner Diameter</i>
<b>5. Flexi-Needle Sharp, without Luer Lock, with Tungsten Obturator**</b>			
14 Gauge	355-**	0.083"	0.062"
15 Gauge	356-**	0.078"	0.057"
15.5 Gauge	1136-**	0.072"	0.054"
16 Gauge	357-**	0.066"	0.050"
17 Gauge	358-**	0.058"	0.040"
18 Gauge	359-**	0.050"	0.031"
<b>6. Flexi-Needle Sharp, without Luer Lock, with Stainless Steel Obturator**</b>			
13 Gauge	354-**	0.095"	0.078"
14 Gauge	757-**	0.083"	0.062"
15 Gauge	735-**	0.078"	0.057"
15.5 Gauge	971-**	0.072"	0.054"
16 Gauge	751-**	0.066"	0.050"
17 Gauge	743-**	0.058"	0.040"
18 Gauge	765-**	0.050"	0.031"
<b>7. Flexi-Needle Sharp, without Luer Lock, with Rod (Tungsten Obturator without Luer Lock)**</b>			
14 Gauge	403-**	0.083"	0.062"
15 Gauge	404-**	0.078"	0.057"
16 Gauge	405-**	0.066"	0.050"
17 Gauge	406-**	0.058"	0.040"
18 Gauge	407-**	0.050"	0.031"
<b>8. Flexi-Needle Sharp, without Luer Lock, with Rod (Stainless Steel Obturator without Luer Lock)**</b>			
13 Gauge	402-**	0.095"	0.078"
14 Gauge	759-**	0.083"	0.062"
15 Gauge	737-**	0.078"	0.057"
16 Gauge	753-**	0.066"	0.050"
17 Gauge	745-**	0.058"	0.040"
18 Gauge	767-**	0.050"	0.031"

**\*\* please specify length**

*continues on next page*



<i>Gauge</i>	<i>Part #</i>	<i>Outer Diameter</i>	<i>Inner Diameter</i>
<b>9. Flexi-Needle Blunt End, without Luer Lock, and without Obturator**</b>			
13 Gauge	257-**	0.095"	0.078"
14 Gauge	258-**	0.083"	0.062"
15 Gauge	259-**	0.078"	0.057"
16 Gauge	260-**	0.066"	0.050"
17 Gauge	261-**	0.058"	0.040"
18 Gauge	262-**	0.050"	0.031"
<b>10. Flexi-Needle Blunt End with Luer Lock, without Obturator**</b>			
13 Gauge	269-**	0.095"	0.078"
14 Gauge	270-**	0.083"	0.062"
15 Gauge	271-**	0.078"	0.057"
16 Gauge	272-**	0.066"	0.050"
17 Gauge	273-**	0.058"	0.040"
18 Gauge	274-**	0.050"	0.031"
<b>11. Flexi-Needle Blunt End with Luer Lock and Tungsten Obturator**</b>			
14 Gauge	276-**	0.083"	0.062"
15 Gauge	277-**	0.078"	0.057"
15.5 Gauge	1695-**	0.072"	0.054"
16 Gauge	278-**	0.066"	0.050"
17 Gauge	279-**	0.058"	0.040"
18 Gauge	280-**	0.050"	0.031"
<b>12. Flexi-Needle Blunt End with Luer Lock and Stainless Steel Obturator</b>			
13 Gauge	275-**	0.095"	0.078"
14 Gauge	756-**	0.083"	0.062"
15 Gauge	734-**	0.078"	0.057"
15.5 Gauge	1137-**	0.078"	0.054"
16 Gauge	750-**	0.066"	0.050"
17 Gauge	742-**	0.058"	0.040"
18 Gauge	764-**	0.050"	0.031"

**\*\* please specify length**

*continues on next page*



<i>Gauge</i>	<i>Part #</i>	<i>Outer Diameter</i>	<i>Inner Diameter</i>
<b>13. Flexi-Needle Blunt End, without Luer Lock, with Tungsten Obturator**</b>			
14 Gauge	361-**	0.083"	0.062"
15 Gauge	362-**	0.078"	0.057"
16 Gauge	363-**	0.066"	0.050"
17 Gauge	364-**	0.058"	0.040"
18 Gauge	365-**	0.050"	0.031"
<b>14. Flexi-Needle Blunt End, without Luer Lock, with Stainless Steel Obturator**</b>			
13 Gauge	360-**	0.095"	0.078"
14 Gauge	758-**	0.083"	0.062"
15 Gauge	736-**	0.078"	0.057"
16 Gauge	751-**	0.066"	0.050"
17 Gauge	744-**	0.058"	0.040"
18 Gauge	766-**	0.050"	0.031"
<b>15. Flexi-Needle Blunt End, without Luer Lock, with Rod (Tungsten Obturator without Luer Lock)**</b>			
14 Gauge	409-**	0.083"	0.062"
15 Gauge	410-**	0.078"	0.057"
15.5 Gauge	970-**	0.072"	0.054"
16 Gauge	411-**	0.066"	0.050"
17 Gauge	412-**	0.058"	0.040"
18 Gauge	413-**	0.050"	0.031"
<b>16. Flexi-Needle Blunt End without, Luer Lock, with Rod (Obturator Stainless Steel without Luer Lock)</b>			
13 Gauge	408-**	0.095"	0.078"
14 Gauge	760-**	0.083"	0.062"
15 Gauge	738-**	0.078"	0.057"
16 Gauge	754-**	0.066"	0.050"
17 Gauge	746-**	0.058"	0.040"
18 Gauge	768-**	0.050"	0.031"

**\*\* please specify length**

*continues on next page*



<i>Gauge</i>	<i>Part #</i>	<i>Outer Diameter</i>	<i>Inner Diameter</i>
<b>17. Tungsten Obturator only, with Luer Lock**</b>			
14 Gauge	295-**	0.055"	
15 Gauge	296-**	0.055"	
16 Gauge	297-**	0.042"	
17 Gauge	298-**	0.038"	
18 Gauge	299-**	0.028"	
<b>18. Stainless Steel Obturator only, with Luer Lock</b>			
13 Gauge	294-**	0.071"	
14 Gauge	732-**	0.055"	
15 Gauge	732-**	0.055"	
16 Gauge	748-**	0.042"	
17 Gauge	740-**	0.038"	
18 Gauge	762-**	0.028"	
<b>19. Rod only (Tungsten Obturator, without Luer Lock)**</b>			
14 Gauge	440-**	0.055"	
15 Gauge	440-**	0.055"	
16 Gauge	438-**	0.042"	
17 Gauge	436-**	0.038"	
18 Gauge	435-**	0.028"	
<b>20. Rod only (Stainless Steel Obturator, without Luer Lock)</b>			
13 Gauge	472-**	0.071"	
14 Gauge	731-**	0.055"	
15 Gauge	731-**	0.055"	
16 Gauge	747-**	0.042"	
17 Gauge	739-**	0.038"	
18 Gauge	761-**	0.028"	

**\*\* please specify length**

Sterile Flexi-Needles		
Part #	Needle Type	Quantity
1500	13 Gauge Flexi-Needle with Stainless Steel Obturator	Up to 5
1723	13 Gauge Printed Needle with Stainless Steel Obturator in a Pouch	Up to 5
1545	Stainless Steel Obturators for 13 Gauge Flexi Needles	Up to 5
1547	13 Gauge with Luer Lock without Obturator	Up to 10
1814	13 Gauge Blunt with Luer Lock without Obturator in a Pouch	Up to 10
1816	13 Gauge Blunt with Stainless Steel Obturator in a Pouch	Up to 5
1543	13 Gauge Sharp Needles	Up to 10
1549	14 Gauge Sharp Needles	Up to 10
1551	14 Gauge with Luer Lock without Obturator	Up to 10
1597	15 Gauge Set with Tungsten Obturator	20
1569	15 Gauge Set with Tungsten Obturator	15
900	15 Gauge Set with Tungsten Obturator	10
1036	15 Gauge Set with Tungsten Obturator	5
1605	15 Gauge Set with Stainless Steel Obturator	20
1577	15 Gauge Set with Stainless Steel Obturator	15
912	15 Gauge Set with Stainless Steel Obturator	10
1040	15 Gauge Set with Stainless Steel Obturator	5
1117	15 Gauge Set with Stainless Steel Obturator	1
1599	15 Gauge without Luer Lock with Obturator	20
1571	15 Gauge without Luer Lock with Obturator	15
903	15 Gauge without Luer Lock with Obturator	10
1037	15 Gauge without Luer Lock with Obturator	5
1634	15 Gauge without Luer Lock with Obturator in a Pouch	Up to 4
1525	15 Gauge Obturator Assembly with Tungsten Rod	Up to 5
1161	15 Gauge Obturator Assembly with Stainless Steel Rod	5 or 10
1607	15 Gauge without Luer Lock with Stainless Steel Obturator	20
1579	15 Gauge without Luer Lock with Stainless Steel Obturator	15
915	15 Gauge without Luer Lock with Stainless Steel Obturator	10
1041	15 Gauge without Luer Lock with Stainless Steel Obturator	5
1613	15 Gauge Printed without Luer Lock with Obturator	20

*continues on next page*



**CAUTION:** This product should be carefully inspected by your staff prior to clinical use and should be used by authorized personnel only.



Part #	Needle Type	Quantity
1585	15 Gauge Printed without Luer Lock with Obturator	15
940	15 Gauge Printed without Luer Lock with Obturator	10
942	15 Gauge Printed without Luer Lock with Obturator	5
1718	15 Gauge Printed, Sharp End with Tungsten Obturator in a Pouch	1
1144	15 Gauge Flexi-Needle with Luer Lock w/o Obturator	Up to 10
1051	15 Gauge Sharp Needles	10
1164	15 Gauge Sharp Needles	5
1166	15 Gauge Sharp Needles	1
1272	15 Gauge Blunt Needles	Up to 10
1769	15 Gauge Sharp End Flexi Needles 3-colors in a Pouch	18
1778	15 Gauge Flexi Needles Blunt End with Tungsten Obturator	10
1776	15 Gauge Flexi Needles Blunt End with Tungsten Obturator	5
1800	15 Gauge Flexi Needles without Luer Lock, Blunt End, with Stainless Steel Obturator in a tray	10
1798	15 Gauge Flexi Needles without Luer Lock, Blunt End, with Stainless Steel Obturator in a tray	5
1804	15 Gauge Flexi Needles without Luer Lock, Blunt End, with Tungsten Obturator	10
1802	15 Gauge Flexi Needles without Luer Lock, Blunt End, with Tungsten Obturator	5
1855	15 Gauge Flexi Needles Blunt End without Luer Lock with Stainless Steel Obturator in a Tray/Pouch	10
1859	15 Gauge Flexi Needle Blunt End with Luer Lock with Stainless Steel Obturator with Hub and Cap in a Tray	5
1303	15 Gauge Flexi-Needle with Stainless Steel Sleeve	5
1660	0.055" Dia. Tungsten Obturator with Sleeve and Cap	Up to 5
1658	0.055" Dia. Stainless Steel Obturator with Sleeve and Cap	Up to 5
1053	15.5 Gauge Sharp Needles	10
1615	15.5 Gauge Printed without Luer Lock with Obturator	20
1587	15.5 Gauge Printed without Luer Lock with Obturator	15

*continues on next page*

**Custom lengths available.  
 Needles up to 25 cm long will be packed in a tray.  
 Needles over 25 cm long will be packed in a pouch.**

<b>Part #</b>	<b>Needle Type</b>	<b>Quantity</b>
944	15.5 Gauge Printed without Luer Lock with Obturator	10
946	15.5 Gauge Printed without Luer Lock with Obturator	5
1527	15.5 Gauge with Luer Lock without Obturator	Up to 10
1339	15.5 Gauge Flexi-Needle with Stainless Steel Sleeve	Max of 10
1840	15.5 Gauge Flexi Needle without Luer Lock with Obturator in a Tray	10
1838	15.5 Gauge Flexi Needle without Luer Lock with Obturator in a Tray/Pouch	5
1836	15.5 Gauge Flexi Needle without Luer Lock with Obturator in a Pouch	Max of 4
1842	15.5 Gauge Flexi Needle Blunt End without Luer Lock with Stainless Steel Obturator in a Tray/Pouch	5
1844	15.5 Gauge Flexi Needle Blunt End without Luer Lock with Stainless Steel Obturator in a Tray	10
1601	16 Gauge Set with Tungsten Obturator	20
1573	16 Gauge Set with Tungsten Obturator	15
906	16 Gauge Set with Tungsten Obturator	10
1036	16 Gauge Set with Tungsten Obturator	5
1609	16 Gauge Set with Stainless Steel Obturator	20
1581	16 Gauge Set with Stainless Steel Obturator	15
918	16 Gauge Set with Stainless Steel Obturator	10
1042	16 Gauge Set with Stainless Steel Obturator	5
1212	16 Gauge Blunt End with Stainless Steel Obturator	1
1514	16 Gauge Sharpe End with Stainless Steel Obturator	Up to 4
1531	16 Gauge with Luer Lock without Obturator in a Pouch	Up to 10
1621	16 Gauge without Luer Lock with Obturator	20
1593	16 Gauge without Luer Lock with Obturator	15
974	16 Gauge without Luer Lock with Obturator	10
1055	16 Gauge Sharp Needles	10
1350	16 Gauge Printed Sharp End Flexi-Needles	5
1617	16 Gauge Printed without Luer Lock with Obturator	20
1589	16 Gauge Printed without Luer Lock with Obturator	15
948	16 Gauge Printed without Luer Lock with Obturator	10
950	16 Gauge Printed without Luer Lock with Obturator	5

*continues on next page*

**Custom lengths available.  
Needles up to 25 cm long will be packed in a tray.  
Needles over 25 cm long will be packed in a pouch.**



<i>Part #</i>	<i>Needle Type</i>	<i>Quantity</i>
1060	16 Gauge Blunt End with Luer Lock	1
1216	16 Gauge Sharp Needles	5
1179	16 Gauge Flexi-Needle without Luer Lock with Hub Stylet	5
1529	16 Gauge Tungsten Obturators	Up to 5
1352	16 Gauge Tungsten Stylets for Needles with Hub	Up to 5
1218	16 Gauge Stainless Steel Obturator	5
1214	16 Gauge Stainless Steel Obturator	1
1861	16 Gauge Flexi Needle Blunt End with Luer Lock with Stainless Steel Obturator in a Pouch	5
1603	17 Gauge Set with Tungsten Obturator	20
1575	17 Gauge Set with Tungsten Obturator	15
909	17 Gauge Set with Tungsten Obturator	10
1669	17 Gauge Set with Tungsten Obturator in a Pouch	Up to 4
1039	17 Gauge Set with Tungsten Obturator	5
1611	17 Gauge Set with Stainless Steel Obturator	20
1583	17 Gauge Set with Stainless Steel Obturator	15
921	17 Gauge Set with Stainless Steel Obturator	10
1671	17 Gauge Set with Stainless Steel Obturator in a Pouch	Up to 4
1867	17 Gauge Flexi Needle Blunt End with Luer Lock with Stainless Steel Obturator in a Tray/Pouch	5
1533	17 Gauge Tungsten Obturators with Rod	Up to 5
1043	17 Gauge Set with Stainless Steel with Obturator in a Tray	5
1698	17 Gauge Flexi Needle without Luer Lock with Stainless Steel Obturators	10
1556	17 Gauge Flexi Needle without Luer Lock with Stainless Steel Obturators	5
1057	17 Gauge Sharp Needles in a pouch	10
1220	17 Gauge Sharp Needles	5
1535	17 Gauge with Luer Lock without Obturator	Up to 10
1619	17 Gauge Printed without Luer Lock with Obturator	20
1591	17 Gauge Printed without Luer Lock with Obturator	15

*continues on next page*

**Custom lengths available.  
 Needles up to 25 cm long will be packed in a tray.  
 Needles over 25 cm long will be packed in a pouch.**

<i>Part #</i>	<i>Needle Type</i>	<i>Quantity</i>
952	17 Gauge Printed without Luer Lock with Obturator	10
954	17 Gauge Printed without Luer Lock with Obturator	5
1222	17 Gauge Stainless Steel Obturator for Needle	Up to 5
1623	18 Gauge Set with Tungsten Obturator	20
1595	18 Gauge Set with Tungsten Obturator	15
1276	18 Gauge Set with Tungsten Obturator	10
1278	18 Gauge Set with Tungsten Obturator	5
1541	18 Gauge with Luer Lock without Obturators	Up to 10
1280	18 Gauge Sharp Needles	Up to 10
1774	18 Gauge Set with Tungsten Obturators	Max of 4
1537	18 Gauge Tungsten Obturators in a Pouch	Up to 5
1539	18 Gauge Stainless Steel Obturators in a Pouch	Up to 5
1157	Flexi-Needle Insertion Kit	1 Kit

**Custom lengths available.  
 Needles up to 25 cm long will be packed in a tray.  
 Needles over 25 cm long will be packed in a pouch.**



# Best<sup>®</sup> medical *international*

## Gold Fiducial Markers



## Marker Kits

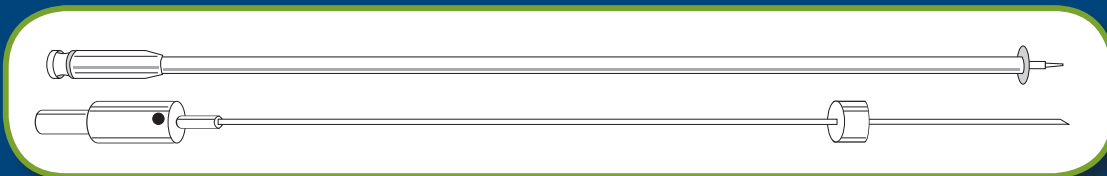
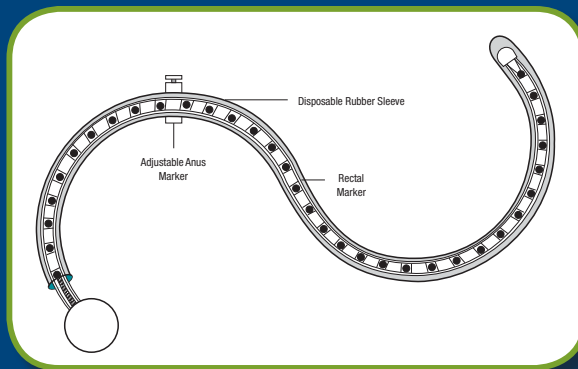



## Marker Kit/Gold Fiducial Markers

*Accurate localization for soft tissue targets*

### Best® Fiducial Marker Kit



Sterile Kit of 4 Needles with Marker in Each



Sterile Kit with Single Marker in Needle



Sterile Kit with 5 Markers (loose)

### Best® Gold Markers



Best Medical's gold markers are available in a variety of diameters and lengths to meet your needs for soft tissue localization such as prostate, liver, pancreas, lung, and breast.

- Best® gold markers are available now in tissue-absorbable strands (patent pending)
- Standard strand consists of two markers at 2 cm apart center to center
- Special marker strands with custom spacing are also available
- Excellent visualization under X-ray, Fluoro, CT, MRI, Ultrasound and other imaging modalities
- Sold individually, stranded, and in pre-loaded, pre-sterilized needle sets
- Can be used for Brachytherapy, IMRT and IGRT

Diameters	Varying Lengths
0.8	1.5 mm
	3 mm
	5 mm
	7 mm
1.0 mm	1.5 mm
	3 mm
	5 mm
	7 mm
1.2 mm	3 mm
	5 mm

**CAUTION:** This product should be carefully inspected by your staff prior to clinical use and should be used by authorized personnel only.

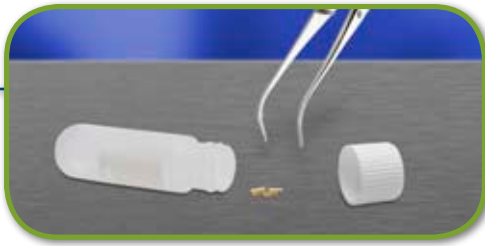

<b>Sterile Loose Gold Markers with Forceps</b>	
<i>Part #</i>	<i>Description</i>
782-1	0.8 mm Diameter, 3 mm Long (5 markers)
782-2	0.8 mm Diameter, 5 mm Long (5 markers)
782-3	0.8 mm Diameter, 7 mm Long (5 markers)
782-5	0.8 mm Diameter, 1.5 mm Long (5 markers)
784-1	1.0 mm Diameter, 3 mm Long (5 markers)
784-2	1.0 mm Diameter, 5 mm Long (5 markers)
784-3	1.0 mm Diameter, 7 mm Long (5 markers)
784-5	1.0 mm Diameter, 1.5 mm Long (5 markers)
785-1	1.2 mm Siameter, 3 mm Long (5 markers)
785-2	1.2 mm Diameter, 5 mm Long (5 markers)

<b>Sterile Loose Stainless Steel Markers with Forceps</b>	
<i>Part #</i>	<i>Description</i>
1700	Stainless Steel Marker Kit (5 markers)

<b>Sterile Iodine Dummy Sources in a Vial</b>	
<i>Part #</i>	<i>Description</i>
10113-50	0.8 mm OD, 5 mm Long Iodine Dummy Sources in a Vial in a Pouch

**Sterile Fiducial Marker Kit • 18 GAUGE • 0.8 mm OD  
10 cm Long Needle • 1 per pack**

<i>Part #</i>	<i>Description</i>
1323-1	18 Gauge, 10 cm Long Pre-waxed Needle (1) Preloaded with 0.8 mm OD, 3 mm Long Gold Marker (1)
1323-2	18 Gauge, 10 cm Long Pre-waxed Needle (1) Preloaded with 0.8 mm OD, 5 mm Long Gold Marker (1)
1323-3	18 Gauge, 10 cm Long Pre-waxed Needle (1) Preloaded with 0.8 mm OD, 7 mm Long Gold Marker (1)
1323-5	18 Gauge, 10 cm Long Pre-waxed Needle (1) Preloaded with 0.8 mm OD, 1.5 mm Long Gold Marker (1)

**Sterile Fiducial Marker Kit • 18 GAUGE • 0.8 mm OD  
10 cm Long Needle • 2 per pack**

<i>Part #</i>	<i>Description</i>
1428-1	18 Gauge, 10 cm Long Pre-waxed Needles (2) Preloaded with 0.8 mm OD, 3 mm Long Gold Marker (1)
1428-2	18 Gauge, 10 cm Long Pre-waxed Needles (2) Preloaded with 0.8 mm OD, 5 mm Long Gold Marker (1)
1428-3	18 Gauge, 10 cm Long Pre-waxed Needles (2) Preloaded with 0.8 mm OD, 7 mm Long Gold Marker (1)
1428-5	18 Gauge, 10 cm Long Pre-waxed Needles (2) Preloaded with 0.8 mm OD, 1.5 mm Long Gold Marker (1)

**Sterile Fiducial Marker Kit • 18 GAUGE • 0.8 mm OD  
10 cm Long Needle • 3 per pack**

<i>Part #</i>	<i>Description</i>
1325-1	18 Gauge, 10 cm Long Pre-waxed Needles (3) Preloaded with 0.8 mm OD, 3 mm Long Gold Marker (1)
1325-2	18 Gauge, 10 cm Long Pre-waxed Needles (3) Preloaded with 0.8 mm OD, 5 mm Long Gold Marker (1)
1325-3	18 Gauge, 10 cm Long Pre-waxed Needles (3) Preloaded with 0.8 mm OD, 7 mm Long Gold Marker (1)
1325-5	18 Gauge, 10 cm Long Pre-waxed Needles (3) Preloaded with 0.8 mm OD, 1.5 mm Long Gold Marker (1)



**Sterile Fiducial Marker Kit • 18 GAUGE • 0.8 mm OD  
15 cm Long Needle • Select 1–4 per pack**

Part #	Description
1643-1-X*	18 Gauge, 15 cm Long Pre-waxed Needle(s) Preloaded with 0.8 mm OD, 3 mm Long Gold Marker (1)
1643-2-X*	18 Gauge, 15 cm Long Pre-waxed Needle(s) Preloaded with 0.8 mm OD, 5 mm Long Gold Marker (1)
1643-3-X*	18 Gauge, 15 cm Long Pre-waxed Needle(s) Preloaded with 0.8 mm OD, 7 mm Long Gold Marker (1)
1643-5-X*	18 Gauge, 15 cm Long Pre-waxed Needle(s) Preloaded with 0.8 mm OD, 1.5 mm Long Gold Marker (1)

\* X refers to selected number of needles per pack, maximum 4 needles

**Sterile Fiducial Marker Kit • 18 GAUGE • 0.8 mm OD  
20 cm Long Needle • 1 per pack**

Part #	Description
1004-1	18 Gauge, 20 cm Long Pre-waxed needle (1) Preloaded with 0.8 mm OD, 3 mm Long Gold Marker (1)
1004-2	18 Gauge, 20 cm Long Pre-waxed needle (1) Preloaded with 0.8 mm OD, 5 mm Long Gold Marker (1)
1004-3	18 Gauge, 20 cm Long Pre-waxed needle (1) Preloaded with 0.8 mm OD, 7 mm Long Gold Marker (1)
1004-5	18 Gauge, 20 cm Long Pre-waxed needle (1) Preloaded with 0.8 mm OD, 1.5 mm Long Gold Marker (1)

**Sterile Fiducial Marker Kit • 18 GAUGE • 0.8 mm OD  
20 cm Long Needle • 2 per pack**

Part #	Description
1430-1	18 Gauge, 20 cm Long Pre-waxed Needles (2) Preloaded with 0.8 mm OD, 3 mm Long Gold Marker (1)
1430-2	18 Gauge, 20 cm Long Pre-waxed Needles (2) Preloaded with 0.8 mm OD, 5 mm Long Gold Marker (1)
1430-3	18 Gauge, 20 cm Long Pre-waxed Needles (2) Preloaded with 0.8 mm OD, 7 mm Long Gold Marker (1)
1430-5	18 Gauge, 20 cm Long Pre-waxed Needles (2) Preloaded with 0.8 mm OD, 1.5 mm Long Gold Marker (1)

**Sterile Fiducial Marker Kit • 18 GAUGE • 0.8 mm OD  
20 cm Long Needle • 3 per pack**

<i>Part #</i>	<i>Description</i>
1017-1	18 Gauge, 20 cm Long Pre-waxed Needles (3) Preloaded with 0.8 mm OD, 3 mm Long Gold Marker (1)
1017-2	18 Gauge, 20 cm Long Pre-waxed Needles (3) Preloaded with 0.8 mm OD, 5 mm Long Gold Marker (1)
1017-3	18 Gauge, 20 cm Long Pre-waxed Needles (3) Preloaded with 0.8 mm OD, 7 mm Long Gold Marker (1)
1017-5	18 Gauge, 20 cm Long Pre-waxed Needles (3) Preloaded with 0.8 mm OD, 1.5 mm Long Gold Marker (1)

**Sterile Fiducial Marker Kit • 18 GAUGE • 0.8 mm OD  
20 cm Long Needle • 4 per pack**

<i>Part #</i>	<i>Description</i>
1168-1	18 Gauge, 20 cm Long Pre-waxed Needles (4) Preloaded with 0.8 mm OD, 3 mm Long Gold Marker (1)
1168-2	18 Gauge, 20 cm long Pre-waxed needles (4) Preloaded with 0.8 mm OD, 5 mm Long Gold Marker (1)
1168-3	18 Gauge, 20 cm long Pre-waxed needles (4) Preloaded with 0.8 mm OD, 7 mm Long Gold Marker (1)
1168-5	18 Gauge, 15 cm long Pre-waxed needles (4) Preloaded with 0.8 mm OD, 1.5 mm Long Gold Marker (1)

**Sterile Fiducial Marker Kit • 18 GAUGE • 0.8 mm OD  
30 cm Long Needle • Select 1–4 per pack**

<i>Part #</i>	<i>Description</i>
1509-1-X*	18 Gauge, 30 cm Long Pre-waxed Needle(s) Preloaded with 0.8 mm OD, 3 mm Long Gold Marker (1)
1509-2-X*	18 Gauge, 30 cm Long Pre-waxed Needle(s) Preloaded with 0.8 mm OD, 5 mm Long Gold Marker (1)
1509-3-X*	18 Gauge, 30 cm Long Pre-waxed Needle(s) Preloaded with 0.8 mm OD, 7 mm Long Gold Marker (1)
1509-5-X*	18 gauge, 30 cm Long Pre-waxed Needle(s) Preloaded with 0.8 mm OD, 1.5 mm Long Gold Marker (1)

\* X refers to selected number of needles per pack, maximum 4 needles



<b>Sterile Fiducial Marker Kit • 18 GAUGE • 1.0 mm OD 10 cm Long Needle • 1 per pack</b>	
<i>Part #</i>	<i>Description</i>
1318-1	18 Gauge, 10 cm Long Pre-waxed Needle (1) Preloaded with 1.0 mm OD, 3 mm Long Gold Marker (1)
1318-2	18 Gauge, 10 cm Long Pre-waxed Needle (1) Preloaded with 1.0 mm OD, 5 mm Long Gold Marker (1)
1318-3	18 Gauge, 10 cm Long Pre-waxed Needle (1) Preloaded with 1.0 mm OD, 7 mm Long Gold Marker (1)
1318-5	18 Gauge, 10 cm Long Pre-waxed Needle (1) Preloaded with 1.0 mm OD, 1.5 mm Long Gold Marker (1)

<b>Sterile Fiducial Marker Kit • 18 GAUGE • 1.0 mm OD 10 cm Long Needle • 2 per pack</b>	
<i>Part #</i>	<i>Description</i>
1432-1	18 Gauge, 10 cm Long Pre-waxed Needles (2) Preloaded with 1.0 mm OD, 3 mm Long Gold Marker (1)
1432-2	18 Gauge, 10 cm Long Pre-waxed Needles (2) Preloaded with 1.0 mm OD, 5 mm Long Gold Marker (1)
1432-3	18 Gauge, 10 cm Long Pre-waxed Needles (2) Preloaded with 1.0 mm OD, 7 mm Long Gold Marker (1)
1432-5	18 Gauge, 10 cm Long Pre-waxed Needles (2) Preloaded with 1.0 mm OD, 1.5 mm Long Gold Marker (1)

<b>Sterile Fiducial Marker Kit • 18 GAUGE • 1.0 mm OD 10 cm Long Needle • 3 per pack</b>	
<i>Part #</i>	<i>Description</i>
1320-1	18 Gauge, 10 cm Long Pre-waxed Needles (3) Preloaded with 1.0 mm OD, 3 mm Long Gold Marker (1)
1320-2	18 Gauge, 10 cm Long Pre-waxed Needles (3) Preloaded with 1.0 mm OD, 5 mm Long Gold Marker (1)
1320-3	18 Gauge, 10 cm Long Pre-waxed Needles (3) Preloaded with 1.0 mm OD, 7 mm Long Gold Marker (1)
1320-5	18 Gauge, 10 cm Long Pre-waxed Needles (3) Preloaded with 1.0 mm OD, 1.5 mm Long Gold Marker (1)



**Sterile Fiducial Marker Kit • 18 GAUGE • 1.0 mm OD  
10 cm Long Needle • 4 per pack**

<i>Part #</i>	<i>Description</i>
1713-1	18 Gauge, 10 cm Long Pre-waxed Needles (4) Preloaded with 1.0 mm OD, 3 mm Long Gold Marker (1)
1713-2	18 Gauge, 10 cm Long Pre-waxed Needles (4) Preloaded with 1.0 mm OD, 5 mm Long Gold Marker (1)
1713-3	18 Gauge, 10 cm Long Pre-waxed Needles (4) Preloaded with 1.0 mm OD, 7 mm Long Gold Marker (1)
1713-5	18 Gauge, 10 cm long Pre-waxed Needles (4) Preloaded with 1.0 mm OD, 1.5 mm Long Gold Marker (1)

**Sterile Fiducial Marker Kit • 18 GAUGE • 1.0 mm OD  
15 cm Long Needle • Select 1–4 per pack**

<i>Part #</i>	<i>Description</i>
1646-1-X*	18 Gauge, 15 cm Long Pre-waxed Needle(s) Preloaded with 1.0 mm OD, 3 mm Long Gold Marker (1)
1646-2-X*	18 Gauge, 15 cm Long Pre-waxed Needle(s) Preloaded with 1.0 mm OD, 5 mm Long Gold Marker (1)
1646-3-X*	18 Gauge, 15 cm Long Pre-waxed Needle(s) Preloaded with 1.0 mm OD, 7 mm Long Gold Marker (1)
1646-5-X*	18 Gauge, 15 cm Long Pre-waxed Needle(s) Preloaded with 1.0 mm OD, 1.5 mm Long Gold Marker (1)

\* X refers to selected number of needles per pack, maximum 4 needles



<b>Sterile Fiducial Marker Kit • 18 GAUGE • 1.0 mm OD 20 cm Long Needle • 1 per pack</b>	
<i>Part #</i>	<i>Description</i>
1008-1	18 Gauge, 20 cm Long Pre-waxed Needle (1) Preloaded with 1.0 mm OD, 3 mm Long Gold Marker (1)
1008-2	18 Gauge, 20 cm Long Pre-waxed Needle (1) Preloaded with 1.0 mm OD, 5 mm Long gold marker (1)
1008-3	18 Gauge, 20 cm Long Pre-waxed Needle (1) Preloaded with 1.0 mm OD, 7 mm Long gold marker (1)
1008-5	18 Gauge, 20 cm Long Pre-waxed Needle (1) Preloaded with 1.0 mm OD, 1.5 mm Long Gold Marker (1)

<b>Sterile Fiducial Marker Kit • 18 GAUGE • 1.0 mm OD 20 cm Long Needle • 2 per pack</b>	
<i>Part #</i>	<i>Description</i>
1434-1	18 Gauge, 20 cm Long Pre-waxed Needles (2) Preloaded with 1.0 mm OD, 3 mm Long Gold Marker (1)
1434-2	18 Gauge, 20 cm Long Pre-waxed Needles (2) Preloaded with 1.0 mm OD, 5 mm Long Gold Marker (1)
1434-3	18 Gauge, 20 cm Long Pre-waxed Needles (2) Preloaded with 1.0 mm OD, 7 mm Long Gold Marker (1)
1434-5	18 Gauge, 20 cm Long Pre-waxed Needles (2) Preloaded with 1.0 mm OD, 1.5 mm Long Gold Marker (1)

<b>Sterile Fiducial Marker Kit • 18 GAUGE • 1.0 mm OD 20 cm Long Needle • 3 per pack</b>	
<i>Part #</i>	<i>Description</i>
1019-1	18 Gauge, 20 cm Long Pre-waxed Needles (3) Preloaded with 1.0 mm OD, 3 mm Long Gold Marker (1)
1019-2	18 Gauge, 20 cm Long Pre-waxed Needles (3) Preloaded with 1.0 mm OD, 5 mm Long Gold Marker (1)
1019-3	18 Gauge, 20 cm Long Pre-waxed Needles (3) Preloaded with 1.0 mm OD, 7 mm Long Gold Marker (1)
1019-5	18 Gauge, 20 cm Long Pre-waxed Needles (3) Preloaded with 1.0 mm OD, 1.5 mm Long Gold Marker (1)





<b>Sterile Fiducial Marker Kit • 18 GAUGE • 1.0 mm OD 20 cm Long Needle • 4 per pack</b>	
<i>Part #</i>	<i>Description</i>
1170-1	18 Gauge, 20 cm Long Pre-waxed Needles (4) Preloaded with 1.0 mm OD, 3 mm Long Gold Marker (1)
1170-2	18 Gauge, 20 cm Long Pre-waxed Needles (4) Preloaded with 1.0 mm OD, 5 mm Long Gold Marker (1)
1170-3	18 Gauge, 20 cm Long Pre-waxed Needles (4) Preloaded with 1.0 mm OD, 7 mm Long Gold Marker (1)
1170-5	18 Gauge, 20 cm Long Pre-waxed Needles (4) Preloaded with 1.0 mm OD, 1.5 mm Long Gold Marker (1)

<b>Sterile Fiducial Marker Kit • 18 GAUGE • 1.0 mm OD 30 cm Long Needle • Select 1–4 per pack</b>	
<i>Part #</i>	<i>Description</i>
1512-1-X*	18 Gauge, 30 cm Long Pre-waxed Needle(s) Preloaded with 1.0 mm OD, 3 mm Long Gold Marker (1)
1512-2-X*	18 Gauge, 30 cm Long Pre-waxed Needle(s) Preloaded with 1.0 mm OD, 5 mm Long Gold Marker (1)
1512-3-X*	18 Gauge, 30 cm Long Pre-waxed Needle(s) Preloaded with 1.0 mm OD, 7 mm Long Gold Marker (1)
1512-5-X*	18 Gauge, 30 cm Long Pre-waxed Needle(s) Preloaded with 1.0 mm OD, 1.5 mm Long Gold Marker (1)

\* X refers to selected number of needles per pack, maximum 4 needles



<b>Sterile Fiducial Marker Kit • 17 GAUGE • 1.2 mm OD 20 cm Long Needle • 1 per pack</b>	
<i>Part #</i>	<i>Description</i>
1088-1	17 Gauge, 20 cm Long Pre-waxed Needle (1) Preloaded with 1.2 mm OD, 3 mm Long gold marker (1)
1088-2	17 Gauge, 20 cm Long Pre-waxed Needle (1) Preloaded with 1.2 mm OD, 5 mm Long Gold Marker (1)

<b>Sterile Fiducial Marker Kit • 17 GAUGE • 1.2 mm OD 20 cm Long Needle • 2 per pack</b>	
<i>Part #</i>	<i>Description</i>
1436-1	17 Gauge, 20 cm Long Pre-waxed Needles (2) Preloaded with 1.2 mm OD, 3 mm Long Gold Marker (1)
1436-2	17 Gauge, 20 cm Long Pre-waxed Needles (2) Preloaded with 1.2 mm OD, 5 mm Long Gold Marker (1)

<b>Sterile Fiducial Marker Kit • 17 GAUGE • 1.2 mm OD 20 cm Long Needle • 3 per pack</b>	
<i>Part #</i>	<i>Description</i>
1090-1	17 Gauge, 20 cm Long Pre-waxed Needles (3) Preloaded with 1.2 mm OD, 3 mm Long Gold Marker (1)
1090-2	17 Gauge, 20 cm Long Pre-waxed Needles (3) Preloaded with 1.2 mm OD, 5 mm Long Gold Marker (1)

<b>Sterile Fiducial Marker Kit • 17 GAUGE • 1.2 mm OD 20 cm Long Needle • 4 per pack</b>	
<i>Part #</i>	<i>Description</i>
1172-1	17 Gauge, 20 cm Long Pre-waxed Needles (4) Preloaded with 1.2 mm OD, 3 mm Long Gold Marker (1)
1172-2	17 Gauge, 20 cm Long Pre-waxed Needles (4) Preloaded with 1.2 mm OD, 5 mm Long Gold Marker (1)



**Sterile Fiducial Marker Kit • 17 GAUGE • 1.2 mm OD  
30 cm Long Needle • 1 per pack**

<i>Part #</i>	<i>Description</i>
1031-1	17 Gauge, 30 cm Long Pre-waxed Needle (1) Preloaded with 1.2 mm OD, 3 mm Long Gold Marker (1)
1031-2	17 Gauge, 30 cm Long Pre-waxed Needle (1) Preloaded with 1.2 mm OD, 5 mm Long Gold Marker (1)

**Sterile Fiducial Marker Kit • 17 GAUGE • 1.2 mm OD  
30 cm Long Needle • 2 per pack**

<i>Part #</i>	<i>Description</i>
1438-1	17 Gauge, 30 cm Long Pre-waxed Needles (2) Preloaded with 1.2 mm OD, 3 mm Long Gold Marker (1)
1438-2	17 Gauge, 30 cm Long Pre-waxed Needles (2) Preloaded with 1.2 mm OD, 5 mm Long Gold Marker (1)

**Sterile Fiducial Marker Kit • 17 GAUGE • 1.2 mm OD  
30 cm Long Needle • 3 per pack**

<i>Part #</i>	<i>Description</i>
1033-1	17 Gauge, 30 cm Long Pre-waxed Needles (3) Preloaded with 1.2 mm OD, 3 mm Long Gold Marker (1)
1033-2	17 Gauge, 30 cm Long Pre-waxed Needles (3) Preloaded with 1.2 mm OD, 5 mm Long Gold Marker (1)

**Sterile Fiducial Marker Kit • 17 GAUGE • 1.2 mm OD  
30 cm Long Needle • 4 per pack**

<i>Part #</i>	<i>Description</i>
1662-1	17 gauge, 30 cm Long Pre-waxed Needles (4) Preloaded with 1.2 mm OD, 3 mm Long Gold Marker (1)
1662-2	17 Gauge, 30 cm Long Pre-waxed Needles (4) Preloaded with 1.2 mm OD, 5 mm Long Gold Marker (1)



Sterile Fiducial Marker STRAND Kit • 18 GAUGE • 0.8 mm OD 10 cm Long Needle • 1 per pack	
Part #	Description
1293-1-X*	18 Gauge, 10 cm Long Pre-waxed Needle (1) Preloaded with Absorbable Strand Enclosing 0.8 mm OD, 3 mm Long Gold Marker(s)
1293-2-X*	18 Gauge, 10 cm Long Pre-waxed Needle (1) Preloaded with Absorbable Strand Enclosing 0.8 mm OD, 5 mm Long Gold Marker(s)
1293-3-X*	18 Gauge, 10 cm Long Pre-waxed Needle (1) Preloaded with Absorbable Strand Enclosing 0.8 mm OD, 7 mm Long Gold Marker(s)
1293-5-X*	18 Gauge, 10 cm Long Pre-waxed Needle (1) Preloaded with Absorbable Strand Enclosing 0.8 mm OD, 1.5 mm Long Gold Marker(s)

\* X refers to selected number of markers per needle

Sterile Fiducial Marker STRAND Kit • 18 GAUGE • 0.8 mm OD 10 cm Long Needle • 2 per pack	
Part #	Description
1440-1-X*	18 Gauge, 10 cm Long Pre-waxed Needles (2) Preloaded with Absorbable Strand Enclosing 0.8 mm OD, 3 mm Long Gold Marker(s)
1440-2-X*	18 Gauge, 10 cm Long Pre-waxed Needles (2) Preloaded with Absorbable Strand Enclosing 0.8 mm OD, 5 mm Long Gold Marker(s)
1440-3-X*	18 Gauge, 10 cm Long Pre-waxed Needles (2) Preloaded with Absorbable Strand Enclosing 0.8 mm OD, 7 mm Long Gold Marker(s)
1440-5-X*	18 Gauge, 10 cm Long Pre-waxed Needles (2) Preloaded with Absorbable Strand Enclosing 0.8 mm OD, 1.5 mm Long Gold Marker(s)

\* X refers to selected number of markers per needle

Sterile Fiducial Marker STRAND Kit • 18 GAUGE • 0.8 mm OD 10 cm Long Needle • 3 per pack	
Part #	Description
1295-1-X*	18 Gauge, 10 cm Long Pre-waxed Needles (3) Preloaded with Absorbable Strand Enclosing 0.8 mm OD, 3 mm Long Gold Marker(s)
1295-2-X*	18 Gauge, 10 cm Long Pre-waxed Needles (3) Preloaded with Absorbable Strand Enclosing 0.8 mm OD, 5 mm Long Gold Marker(s)
1295-3-X*	18 Gauge, 10 cm Long Pre-waxed Needles (3) Preloaded with Absorbable Strand Enclosing 0.8 mm OD, 7 mm Long Gold Marker(s)
1295-5-X*	18 Gauge, 10 cm Long Pre-waxed Needles (3) Preloaded with Absorbable Strand Enclosing 0.8 mm OD, 1.5 mm Long Gold Marker(s)

\* X refers to selected number of markers per needle



**Sterile Fiducial Marker STRAND Kit • 18 GAUGE • 0.8 mm OD  
15 cm Long Needle • 1 per pack**

<i>Part #</i>	<i>Description</i>
1649-1-X*	18 Gauge, 15 cm Long Pre-waxed Needle (1) Preloaded with Absorbable Strand Enclosing 0.8 mm OD, 3 mm Long Gold Marker(s)
1649-2-X*	18 Gauge, 15 cm Long Pre-waxed Needle (1) Preloaded with Absorbable Strand Enclosing 0.8 mm OD, 5 mm Long Gold Marker(s)
1649-3-X*	18 Gauge, 15 cm Long Pre-waxed Needle (1) Preloaded with Absorbable Strand Enclosing 0.8 mm OD, 7 mm Long Gold Marker(s)
1649-5-X*	18 Gauge, 15 cm Long Pre-waxed Needle (1) Preloaded with Absorbable Strand Enclosing 0.8 mm OD, 1.5 mm Long Gold Marker(s)

\* X refers to selected number of markers per needle

**Sterile Fiducial Marker STRAND Kit • 18 GAUGE • 0.8 mm OD  
15 cm Long Needle • 2 per pack**

<i>Part #</i>	<i>Description</i>
1651-1-X*	18 Gauge, 15 cm Long Pre-waxed Needles (2) Preloaded with Absorbable Strand Enclosing 0.8 mm OD, 3 mm Long Gold Marker(s)
1651-2-X*	18 Gauge, 15 cm Long Pre-waxed Needles (2) Preloaded with Absorbable Strand Enclosing 0.8 mm OD, 5 mm Long Gold Marker(s)
1651-3-X*	18 Gauge, 15 cm Long Pre-waxed Needles (2) Preloaded with Absorbable Strand Enclosing 0.8 mm OD, 7 mm Long Gold Marker(s)
1651-5-X*	18 Gauge, 15 cm Long Pre-waxed Needles (2) Preloaded with Absorbable Strand Enclosing 0.8 mm OD, 1.5 mm Long Gold Marker(s)

\* X refers to selected number of markers per needle

**Sterile Fiducial Marker STRAND Kit • 18 GAUGE • 0.8 mm OD  
15 cm Long Needle • 3 per pack**

<i>Part #</i>	<i>Description</i>
1653-1-X*	18 Gauge, 15 cm Long Pre-waxed Needles (3) Preloaded with Absorbable Strand Enclosing 0.8 mm OD, 3 mm Long Gold Marker(s)
1653-2-X*	18 Gauge, 15 cm Long Pre-waxed Needles (3) Preloaded with Absorbable Strand Enclosing 0.8 mm OD, 5 mm Long Gold Marker(s)
1653-3-X*	18 Gauge, 15 cm Long Pre-waxed Needles (3) Preloaded with Absorbable Strand Enclosing 0.8 mm OD, 7 mm Long Gold Marker(s)
1653-5-X*	18 Gauge, 15 cm long Pre-waxed Needles (3) Preloaded with Absorbable Strand Enclosing 0.8 mm OD, 1.5 mm Long Gold Marker(s)

\* X refers to selected number of markers per needle



Sterile Fiducial Marker STRAND Kit • 18 GAUGE • 0.8 mm OD 20 cm Long Needle • 1 per pack	
Part #	Description
1013-1-X*	18 Gauge, 20 cm Long Pre-waxed Needle (1) Preloaded with Absorbable Strand Enclosing 0.8 mm OD, 3 mm Long Gold Marker(s)
1013-2-X*	18 Gauge, 20 cm Long Pre-waxed Needle (1) Preloaded with Absorbable Strand Enclosing 0.8 mm OD, 5 mm Long Gold Marker(s)
1013-3-X*	18 Gauge, 20 cm Long Pre-waxed Needle (1) Preloaded with absorbable strand enclosing 0.8 mm OD, 7 mm Long Gold Marker(s)
1013-5-X*	18 Gauge, 20 cm Long Pre-waxed Needle (1) Preloaded with Absorbable Strand Enclosing 0.8 mm OD, 1.5 mm Long Gold Marker(s)

\* X refers to selected number of markers per needle

Sterile Fiducial Marker STRAND Kit • 18 GAUGE • 0.8 mm OD 20 cm Long Needle • 2 per pack	
Part #	Description
1442-1-X*	18 Gauge, 20 cm Long Pre-waxed Needles (2) Preloaded with Absorbable Strand Enclosing 0.8 mm OD, 3 mm Long Gold Marker(s)
1442-2-X*	18 Gauge, 20 cm Long Pre-waxed Needles (2) Preloaded with Absorbable Strand Enclosing 0.8 mm OD, 5 mm Long Gold Marker(s)
1442-3-X*	18 Gauge, 20 cm Long Pre-waxed Needles (2) Preloaded with Absorbable Strand Enclosing 0.8 mm OD, 7 mm Long Gold Marker(s)
1442-5-X*	18 Gauge, 20 cm Long Pre-waxed Needles (2) Preloaded with Absorbable Strand Enclosing 0.8 mm OD, 1.5 mm Long Gold Marker(s)

\* X refers to selected number of markers per needle

Sterile Fiducial Marker STRAND Kit • 18 GAUGE • 0.8 mm OD 20 cm Long Needle • 3 per pack	
Part #	Description
1015-1-X*	18 Gauge, 20 cm Long Pre-waxed Needles (3) Preloaded with Absorbable Strand Enclosing 0.8 mm OD, 3 mm Long Gold Marker(s)
1015-2-X*	18 Gauge, 20 cm Long Pre-waxed Needles (3) Preloaded with Absorbable Strand Enclosing 0.8 mm OD, 5 mm Long Gold Marker(s)
1015-3-X*	18 Gauge, 20 cm Long Pre-waxed Needles (3) Preloaded with Absorbable Strand Enclosing 0.8 mm OD, 7 mm Long Gold Marker(s)
1015-5-X*	18 Gauge, 20 cm Long Pre-waxed Needles (3) Preloaded with Absorbable Strand Enclosing 0.8 mm OD, 1.5 mm Long Gold Marker(s)

\* X refers to selected number of markers per needle



**Sterile Fiducial Marker STRAND Kit • 17 GAUGE • 0.8 mm OD  
30 cm Long Needle • 1 per pack**

<i>Part #</i>	<i>Description</i>
1130-1-X*	17 Gauge, 30 cm Long Pre-waxed Needle (1) Preloaded with Absorbable Strand Enclosing 0.8 mm OD, 3 mm Long Gold Marker(s)
1130-2-X*	17 Gauge, 30 cm Long Pre-waxed Needle (1) Preloaded with Absorbable Strand Enclosing 0.8 mm OD, 5 mm Long Gold Marker(s)
1130-3-X*	17 Gauge, 30 cm Long Pre-waxed Needle (1) Preloaded with Absorbable Strand Enclosing 0.8 mm OD, 7 mm Long Gold Marker(s)
1130-5-X*	17 Gauge, 30 cm Long Pre-waxed Needle (1) Preloaded with Absorbable Strand Enclosing 0.8 mm OD, 1.5 mm Long Gold Marker(s)

\* X refers to selected number of markers per needle

**Sterile Fiducial Marker STRAND Kit • 17 GAUGE • 0.8 mm OD  
30 cm Long Needle • 2 per pack**

<i>Part #</i>	<i>Description</i>
1444-1-X*	17 Gauge, 30 cm Long Pre-waxed Needles (2) Preloaded with Absorbable Strand Enclosing 0.8 mm OD, 3 mm Long Gold Marker(s)
1444-2-X*	17 Gauge, 30 cm Long Pre-waxed Needles (2) Preloaded with Absorbable Strand Enclosing 0.8 mm OD, 5 mm Long Gold Marker(s)
1444-3-X*	17 Gauge, 30 cm Long Pre-waxed Needles (2) Preloaded with Absorbable Strand Enclosing 0.8 mm OD, 7 mm Long Gold Marker(s)
1444-5-X*	17 Gauge, 30 cm Long Pre-waxed Needles (2) Preloaded with Absorbable Strand Enclosing 0.8 mm OD, 1.5 mm Long Gold Marker(s)

\* X refers to selected number of markers per needle

**Sterile Fiducial Marker STRAND Kit • 17 GAUGE • 0.8 mm OD  
30 cm Long Needle • 3 per pack**

<i>Part #</i>	<i>Description</i>
1132-1-X*	17 Gauge, 30 cm Long Pre-waxed Needles (3) Preloaded with Absorbable Strand Enclosing 0.8 mm OD, 3 mm Long Gold Marker(s)
1132-2-X*	17 Gauge, 30 cm Long Pre-waxed Needles (3) Preloaded with Absorbable Strand Enclosing 0.8 mm OD, 5 mm Long Gold Marker(s)
1132-3-X*	17 Gauge, 30 cm Long Pre-waxed Needles (3) Preloaded with Absorbable Strand Enclosing 0.8 mm OD, 7 mm Long Gold Marker(s)
1132-5-X*	17 Gauge, 30 cm Long Pre-waxed Needles (3) Preloaded with Absorbable Strand Enclosing 0.8 mm OD, 1.5 mm Long Gold Marker(s)

\* X refers to selected number of markers per needle



Sterile Fiducial Marker STRAND Kit • 17 GAUGE • 1.0 mm OD 10 cm Long Needle • 1 per pack	
Part #	Description
1357-1-X*	17 Gauge, 10 cm Long Pre-waxed Needle (1) Preloaded with Absorbable Strand Enclosing 1.0 mm OD, 3 mm Long Gold Marker(s)
1357-2-X*	17 Gauge, 10 cm Long Pre-waxed Needle (1) Preloaded with Absorbable Strand Enclosing 1.0 mm OD, 5 mm Long Gold Marker(s)
1357-3-X*	17 Gauge, 10 cm Long Pre-waxed Needle (1) Preloaded with Absorbable Strand Enclosing 1.0 mm OD, 7 mm Long Gold Marker(s)
1357-5-X*	17 Gauge, 10 cm Long Pre-waxed Needle (1) Preloaded with Absorbable Strand Enclosing 1.0 mm OD, 1.5 mm Long Gold Marker(s)

\* X refers to selected number of markers per needle

Sterile Fiducial Marker STRAND Kit • 17 GAUGE • 1.0 mm OD 10 cm Long Needle • 2 per pack	
Part #	Description
1446-1-X*	17 Gauge, 10 cm Long Pre-waxed Needles (2) Preloaded with Absorbable Strand Enclosing 1.0 mm OD, 3 mm Long Gold Marker(s)
1446-2-X*	17 Gauge, 10 cm Long Pre-waxed Needles (2) Preloaded with Absorbable Strand Enclosing 1.0 mm OD, 5 mm Long Gold Marker(s)
1446-3-X*	17 Gauge, 10 cm Long Pre-waxed Needles (2) Preloaded with Absorbable Strand Enclosing 1.0 mm OD, 7 mm Long Gold Marker(s)
1446-5-X*	17 Gauge, 10 cm Long Pre-waxed Needles (2) Preloaded with Absorbable Strand Enclosing 1.0 mm OD, 1.5 mm Long Gold Marker(s)

\* X refers to selected number of markers per needle

Sterile Fiducial Marker STRAND Kit • 17 GAUGE • 1.0 mm OD 10 cm Long Needle • 3 per pack	
Part #	Description
1359-1-X*	17 Gauge, 10 cm Long Pre-waxed Needles (3) Preloaded with Absorbable Strand Enclosing 1.0 mm OD, 3 mm Long Gold Marker(s)
1359-2-X*	17 Gauge, 10 cm Long Pre-waxed Needles (3) Preloaded with Absorbable Strand Enclosing 1.0 mm OD, 5 mm Long Gold Marker(s)
1359-3-X*	17 Gauge, 10 cm Long Pre-waxed Needles (3) Preloaded with Absorbable Strand Enclosing 1.0 mm OD, 7 mm Long Gold Marker(s)
1359-5-X*	17 Gauge, 10 cm Long Pre-waxed Needles (3) Preloaded with Absorbable Strand Enclosing 1.0 mm OD, 1.5 mm Long Gold Marker(s)

\* X refers to selected number of markers per needle





**Sterile Fiducial Marker STRAND Kit • 17 GAUGE • 1.0 mm OD  
20 cm Long Needle • 1 per pack**

<i>Part #</i>	<i>Description</i>
1268-1-X*	17 Gauge, 20 cm Long Pre-waxed Needle (1) Preloaded with Absorbable Strand Enclosing 1.0 mm OD, 3 mm Long Gold Marker(s)
1268-2-X*	17 Gauge, 20 cm Long Pre-waxed Needle (1) Preloaded with Absorbable Strand Enclosing 1.0 mm OD, 5 mm Long Gold Marker(s)
1268-3-X*	17 Gauge, 20 cm Long Pre-waxed Needle (1) Preloaded with Absorbable Strand Enclosing 1.0 mm OD, 7 mm Long Gold Marker(s)
1268-5-X*	17 Gauge, 20 cm Long Pre-waxed Needle (1) Preloaded with Absorbable Strand Enclosing 1.0 mm OD, 1.5 mm Long Gold Marker(s)

\* X refers to selected number of markers per needle

**Sterile Fiducial Marker STRAND Kit • 17 GAUGE • 1.0 mm OD  
20 cm Long Needle • 2 per pack**

<i>Part #</i>	<i>Description</i>
1448-1-X*	17 Gauge, 20 cm Long Pre-waxed Needles (2) Preloaded with Absorbable Strand Enclosing 1.0 mm OD, 3 mm Long Gold Marker(s)
1448-2-X*	17 Gauge, 20 cm Long Pre-waxed Needles (2) Preloaded with Absorbable Strand Enclosing 1.0 mm OD, 5 mm Long Gold Marker(s)
1448-3-X*	17 Gauge, 20 cm Long Pre-waxed Needles (2) Preloaded with Absorbable Strand Enclosing 1.0 mm OD, 7 mm Long Gold Marker(s)
1448-5-X*	17 Gauge, 20 cm Long Pre-waxed Needles (2) Preloaded with Absorbable Strand Enclosing 1.0 mm OD, 1.5 mm Long Gold Marker(s)

\* X refers to selected number of markers per needle

**Sterile Fiducial Marker STRAND Kit • 17 GAUGE • 1.0 mm OD  
20 cm Long Needle • 3 per pack**

<i>Part #</i>	<i>Description</i>
1270-1-X*	17 Gauge, 20 cm Long Pre-waxed Needles (3) Preloaded with Absorbable Strand Enclosing 1.0 mm OD, 3 mm Long Gold Marker(s)
1270-2-X*	17 Gauge, 20 cm Long Pre-waxed Needles (3) Preloaded with Absorbable Strand Enclosing 1.0 mm OD, 5 mm Long Gold Marker(s)
1270-3-X*	17 Gauge, 20 cm Long Pre-waxed Needles (3) Preloaded with Absorbable Strand Enclosing 1.0 mm OD, 7 mm Long Gold Marker(s)
1270-5-X*	17 Gauge, 20 cm Long Pre-waxed Needles (3) Preloaded with Absorbable Strand Enclosing 1.0 mm OD, 1.5 mm Long Gold Marker(s)

\* X refers to selected number of markers per needle



Sterile Fiducial Marker STRAND Kit • 16 GAUGE • 1.2 mm OD 20 cm Long Needle • 1 per pack	
Part #	Description
1329-1-X*	16 Gauge, 20 cm Long Pre-waxed Needle (1) Preloaded with Absorbable Strand Enclosing 1.2 mm OD, 3 mm Long Gold Marker(s)
1329-2-X*	16 Gauge, 20 cm Long Pre-waxed Needle (1) Preloaded with Absorbable Strand Enclosing 1.2 mm OD, 5 mm Long Gold Marker(s)

\* X refers to selected number of markers per needle

Sterile Fiducial Marker STRAND Kit • 16 GAUGE • 1.2 mm OD 20 cm Long Needle • 2 per pack	
Part #	Description
1450-1-X*	16 Gauge, 20 cm Long Pre-waxed Needles (2) Preloaded with Absorbable Strand Enclosing 1.2 mm OD, 3 mm Long Gold Marker(s)
1450-2-X*	16 Gauge, 20 cm Long Pre-waxed Needles (2) Preloaded with Absorbable Strand Enclosing 1.2 mm OD, 5 mm Long Gold Marker(s)

\* X refers to selected number of markers per needle

Sterile Fiducial Marker STRAND Kit • 16 GAUGE • 1.2 mm OD 20 cm Long Needle • 3 per pack	
Part #	Description
1331-1-X*	16 Gauge, 20 cm Long Pre-waxed Needles (3) Preloaded with Absorbable Strand Enclosing 1.2 mm OD, 3 mm Long Gold Marker(s)
1331-2-X*	16 Gauge, 20 cm Long Pre-waxed Needles (3) Preloaded with Absorbable Strand Enclosing 1.2 mm OD, 5 mm Long Gold Marker(s)

\* X refers to selected number of markers per needle

**Sterile ROUND HUB Needles with  
Iodine Dummy Seeds in Strand • 18 GAUGE • 0.8 mm OD  
10 cm Long Needle • 1 per pack**

<i>Part #</i>	<i>Description</i>
10113-26-X*	18 Gauge, 10 cm Long Pre-waxed Needle (1) Preloaded with Absorbable Strand Enclosing 0.8 mm OD, 5 mm Long Iodine Dummy Seed(s)

\* X refers to selected number of dummy seeds per needle

**Sterile ROUND HUB Needles with  
Iodine Dummy Seeds in Strand • 18 GAUGE • 0.8 mm OD  
10 cm Long Needle • 3 per pack**

<i>Part #</i>	<i>Description</i>
10113-31-X*	18 Gauge, 10 cm Long Pre-waxed Needles (3) Preloaded with Absorbable Strand Enclosing 0.8 mm OD, 5 mm Long Iodine Dummy Seed(s)

\* X refers to selected number of dummy seeds per needle

**Sterile ROUND HUB Needles with  
Iodine Dummy Seeds in Strand • 18 GAUGE • 0.8 mm OD  
15 cm Long Needle • 1 per pack**

<i>Part #</i>	<i>Description</i>
10113-29-X*	18 Gauge, 15 cm Long Pre-waxed Needle (1) Preloaded with Absorbable Strand Enclosing 0.8 mm OD, 5 mm Long Iodine Dummy Seed(s)

\* X refers to selected number of dummy seeds per needle



**Sterile ROUND HUB Needles with  
Iodine Dummy Seeds in Strand • 18 GAUGE • 0.8 mm OD  
15 cm Long Needle • 3 per pack**

<i>Part #</i>	<i>Description</i>
10113-33-X*	18 Gauge, 15 cm Long Pre-waxed Needles (3) Preloaded with Absorbable Strand Enclosing 0.8 mm OD, 5 mm Long Iodine Dummy Seed(s)

\* X refers to selected number of dummy seeds per needle

**Sterile ROUND HUB Needles with  
Iodine Dummy Seeds in Strand • 18 GAUGE • 0.8 mm OD  
20 cm Long Needle • 1 per pack**

<i>Part #</i>	<i>Description</i>
10113-46-X*	18 Gauge, 20 cm Long Pre-waxed Needle (1) Preloaded with Absorbable Strand Enclosing 0.8 mm OD, 5 mm Long Iodine Dummy Seed(s)

\* X refers to selected number of dummy seeds per needle

**Sterile ROUND HUB Needles with  
Iodine Dummy Seeds in Strand • 18 GAUGE • 0.8 mm OD  
20 cm Long Needle • 3 per pack**

<i>Part #</i>	<i>Description</i>
10113-48-X*	18 Gauge, 20 cm Long Pre-waxed Needles (3) Preloaded with Absorbable Strand Enclosing 0.8 mm OD, 5 mm Long Iodine Dummy Seed(s)

\* X refers to selected number of dummy seeds per needle

**Sterile SQUARE HUB Needles with  
Iodine Dummy Seeds in Strand • 18 GAUGE • 0.8 mm OD  
10 cm Long Needle • 1 per pack**

<i>Part #</i>	<i>Description</i>
10113-36-X*	18 Gauge, 10 cm Long Pre-waxed Needle (1) Preloaded with Absorbable Strand Enclosing 0.8 mm O.D, 5 mm Long Iodine Dummy Seed(s)

\* X refers to selected number of dummy seeds per needle

**Sterile SQUARE HUB Needles with  
Iodine Dummy Seeds in Strand • 18 GAUGE • 0.8 mm OD  
10 cm Long Needle • 3 per pack**

<i>Part #</i>	<i>Description</i>
10113-38-X*	18 Gauge, 10 cm Long Pre-waxed Needles (3) Preloaded with Absorbable Strand Enclosing 0.8 mm O.D, 5 mm Long Iodine Dummy Seed(s)

\* X refers to selected number of dummy seeds per needle

**Sterile SQUARE HUB Needles with  
Iodine Dummy Seeds in Strand • 18 GAUGE • 0.8 mm OD  
15 cm Long Needle • 1 per pack**

<i>Part #</i>	<i>Description</i>
10113-41-X*	18 Gauge, 15 cm Long Pre-waxed Needle (1) Preloaded with Absorbable Strand Enclosing 0.8 mm O.D, 5 mm Long Iodine Dummy Seed(s)

\* X refers to selected number of dummy seeds per needle



**Sterile SQUARE HUB Needles with  
Iodine Dummy Seeds in Strand • 18 GAUGE • 0.8 mm OD  
15 cm Long Needle • 3 per pack**

<i>Part #</i>	<i>Description</i>
10113-43-X*	18 Gauge, 15 cm Long Pre-waxed Needles (3) Preloaded with Absorbable Strand Enclosing 0.8 mm OD, 5 mm Long Iodine Dummy Seed(s)

\* X refers to selected number of dummy seeds per needle

**Sterile SQUARE HUB Needles with  
Iodine Dummy Seeds in Strand • 18 GAUGE • 0.8 mm OD  
20 cm Long Needle • 1 per pack**

<i>Part #</i>	<i>Description</i>
10113-17-X*	18 Gauge, 20 cm Long Pre-waxed Needle (1) Preloaded with Absorbable Strand Enclosing 0.8 mm OD, 5 mm Long Iodine Dummy Seed(s)

\* X refers to selected number of dummy seeds per needle

**Sterile SQUARE HUB Needles with  
Iodine Dummy Seeds in Strand • 18 GAUGE • 0.8 mm OD  
20 cm Long Needle • 3 per pack**

<i>Part #</i>	<i>Description</i>
10113-19-X*	18 Gauge, 20 cm Long Pre-waxed Needles (3) Preloaded with Absorbable Strand Enclosing 0.8 mm OD, 5 mm Long Iodine Dummy Seed(s)

\* X refers to selected number of dummy seeds per needle



**Sterile Fiducial Marker with SPACERS Kit • 18 GAUGE • 0.8 mm OD  
20 cm Long Needle • 1 per pack**

<i>Part #</i>	<i>Description</i>
1306-1-X*	18 Gauge, 20 cm Long Pre-waxed Needle (1) Preloaded with 0.8 mm OD, 3 mm Long Gold Marker(s) and Spacer(s)
1306-2-X*	18 Gauge, 20 cm Long Pre-waxed Needle (1) Preloaded with 0.8 mm OD, 5 mm Long Gold Marker(s) and Spacer(s)
1306-3-X*	18 Gauge, 20 cm Long Pre-waxed Needle (1) Preloaded with 0.8 mm OD, 7 mm Long Gold Marker(s) and Spacer(s)
1306-5-X*	18 Gauge, 20 cm Long Pre-waxed Needle (1) Preloaded with 0.8 mm OD, 1.5 mm Long Gold Marker(s) and Spacer(s)

\* X refers to selected number of markers per needle

**Sterile Fiducial Marker with SPACERS Kit • 18 GAUGE • 0.8 mm OD  
20 cm Long Needle • 2 per pack**

<i>Part #</i>	<i>Description</i>
1452-1-X*	18 Gauge, 20 cm Long Pre-waxed Needles (2) Preloaded with 0.8 mm OD, 3 mm Long Gold Marker(s) and Spacer(s)
1452-2-X*	18 Gauge, 20 cm Long Pre-waxed Needles (2) Preloaded with 0.8 mm OD, 5 mm Long Gold Marker(s) and Spacer(s)
1452-3-X*	18 Gauge, 20 cm Long Pre-waxed Needles (2) Preloaded with 0.8 mm OD, 7 mm Long Gold Marker(s) and Spacer(s)
1452-5-X*	18 Gauge, 20 cm Long Pre-waxed Needles (2) Preloaded with 0.8 mm OD, 1.5 mm Long Gold Marker(s) and Spacer(s)

\* X refers to selected number of markers per needle

**Sterile Fiducial Marker with SPACERS Kit • 18 GAUGE • 0.8 mm OD  
20 cm Long Needle • 3 per pack**

<i>Part #</i>	<i>Description</i>
1385-1-X*	18 Gauge, 20 cm Long Pre-waxed Needles (3) Preloaded with 0.8 mm OD, 3 mm Long Gold Marker(s) and Spacer(s)
1385-2-X*	18 Gauge, 20 cm Long Pre-waxed Needles (3) Preloaded with 0.8 mm OD, 5 mm Long Gold Marker(s) and Spacer(s)
1385-3-X*	18 Gauge, 20 cm Long Pre-waxed Needles (3) Preloaded with 0.8 mm OD, 7 mm Long Gold Marker(s) and Spacer(s)
1385-5-X*	18 Gauge, 20 cm Long Pre-waxed Needles (3) Preloaded with 0.8 mm OD, 1.5 mm Long Gold Marker(s) and Spacer(s)

\* X refers to selected number of markers per needle



Sterile Fiducial Marker with SPACERS Kit • 18 GAUGE • 1.0 mm OD 20 cm Long Needle • 1 per pack	
Part #	Description
1309-1-X*	18 Gauge, 20 cm Long Pre-waxed Needle (1) Preloaded with 1.0 mm OD, 3 mm Long Gold Marker(s) and Spacer(s)
1309-2-X*	18 Gauge, 20 cm Long Pre-waxed Needle (1) Preloaded with 1.0 mm OD, 5 mm Long Gold Marker(s) and Spacer(s)
1309-3-X*	18 Gauge, 20 cm Long Pre-waxed Needle (1) Preloaded with 1.0 mm OD, 7 mm Long Gold Marker(s) and Spacer(s)
1309-5-X*	18 Gauge, 20 cm Long Pre-waxed Needle (1) Preloaded with 1.0 mm OD, 1.5 mm Long Gold Marker(s) and Spacer(s)

\* X refers to selected number of markers per needle

Sterile Fiducial Marker with SPACERS Kit • 18 GAUGE • 1.0 mm OD 20 cm Long Needle • 2 per pack	
Part #	Description
1454-1-X*	18 Gauge, 20 cm Long Pre-waxed Needles (2) Preloaded with 1.0 mm OD, 3 mm Long Gold Marker(s) and Spacer(s)
1454-2-X*	18 Gauge, 20 cm Long Pre-waxed Needles (2) Preloaded with 1.0 mm OD, 5 mm Long Gold Marker(s) and Spacer(s)
1454-3-X*	18 Gauge, 20 cm Long Pre-waxed Needles (2) Preloaded with 1.0 mm OD, 7 mm Long Gold Marker(s) and Spacer(s)
1454-5-X*	18 Gauge, 20 cm Long Pre-waxed Needles (2) Preloaded with 1.0 mm OD, 1.5 mm Long Gold Marker(s) and Spacer(s)

\* X refers to selected number of markers per needle

Sterile Fiducial Marker with SPACERS Kit • 18 GAUGE • 1.0 mm OD 20 cm Long Needle • 3 per pack	
Part #	Description
1387-1-X*	18 Gauge, 20 cm Long Pre-waxed Needles (3) Preloaded with 1.0 mm OD, 3 mm Long Gold Marker(s) and Spacer(s)
1387-2-X*	18 Gauge, 20 cm Long Pre-waxed Needles (3) Preloaded with 1.0 mm OD, 5 mm Long Gold Marker(s) and Spacer(s)
1387-3-X*	18 Gauge, 20 cm Long Pre-waxed Needles (3) Preloaded with 1.0 mm OD, 7 mm Long Gold Marker(s) and Spacer(s)
1387-5-X*	18 Gauge, 20 cm Long Pre-waxed Needles (3) Preloaded with 1.0 mm OD, 1.5 mm Long Gold Marker(s) and Spacer(s)

\* X refers to selected number of markers per needle





<b>Sterile Fiducial Marker with SPACERS Kit • 17 GAUGE • 1.2 mm OD 20 cm Long Needle • 1 per pack</b>	
<i>Part #</i>	<i>Description</i>
1312-1-X*	17 Gauge, 20 cm Long Pre-waxed Needle (1) Preloaded with 1.2 mm OD, 3 mm Long Gold Marker(s) and Spacer(s)
1312-2-X*	17 Gauge, 20 cm Long Pre-waxed Needle (1) Preloaded with 1.2 mm OD, 5 mm Long Gold Marker(s) and Spacer(s)

\* X refers to selected number of markers per needle

<b>Sterile Fiducial Marker with SPACERS Kit • 17 GAUGE • 1.2 mm OD 20 cm Long Needle • 2 per pack</b>	
<i>Part #</i>	<i>Description</i>
1456-1-X*	17 Gauge, 20 cm Long Pre-waxed Needles (2) Preloaded with 1.2 mm OD, 3 mm Long Gold Marker(s) and Spacer(s)
1456-2-X*	17 Gauge, 20 cm Long Pre-waxed Needles (2) Preloaded with 1.2 mm OD, 5 mm Long Gold Marker(s) and Spacer(s)

\* X refers to selected number of markers per needle

<b>Sterile Fiducial Marker with SPACERS Kit • 17 GAUGE • 1.2 mm OD 20 cm Long Needle • 3 per pack</b>	
<i>Part #</i>	<i>Description</i>
1389-1-X*	17 Gauge, 20 cm Long Pre-waxed Needles (3) Preloaded with 1.2 mm OD, 3 mm Long Gold Marker(s) and Spacer(s)
1389-2-X*	17 Gauge, 20 cm Long Pre-waxed Needles (3) Preloaded with 1.2 mm OD, 5 mm Long Gold Marker(s) and Spacer(s)

\* X refers to selected number of markers per needle



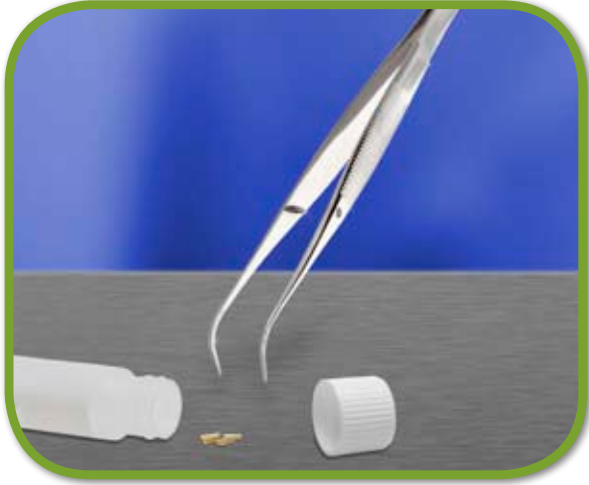

<b>Non-Sterile Loose Gold Markers</b>	
<b>Part #</b>	<b>Description</b>
351-1	0.8 mm Diameter, 3 mm Long
351-2	0.8 mm Diameter, 5 mm Long
351-3	0.8 mm Diameter, 7 mm Long
351-5	0.8 mm Diameter, 1.5 mm Long
353-1	1.0 mm Diameter, 3 mm Long
353-2	1.0 mm Diameter, 5 mm Long
353-3	1.0 mm Diameter, 7 mm Long
353-5	1.0 mm Diameter, 1.5 mm Long
501-1	1.2 mm Diameter, 3 mm Long
501-2	1.2 mm Diameter, 5 mm Long

## Rectal Marker Kit with Anus Marker

Part # 222-1; 222-2 (see below)

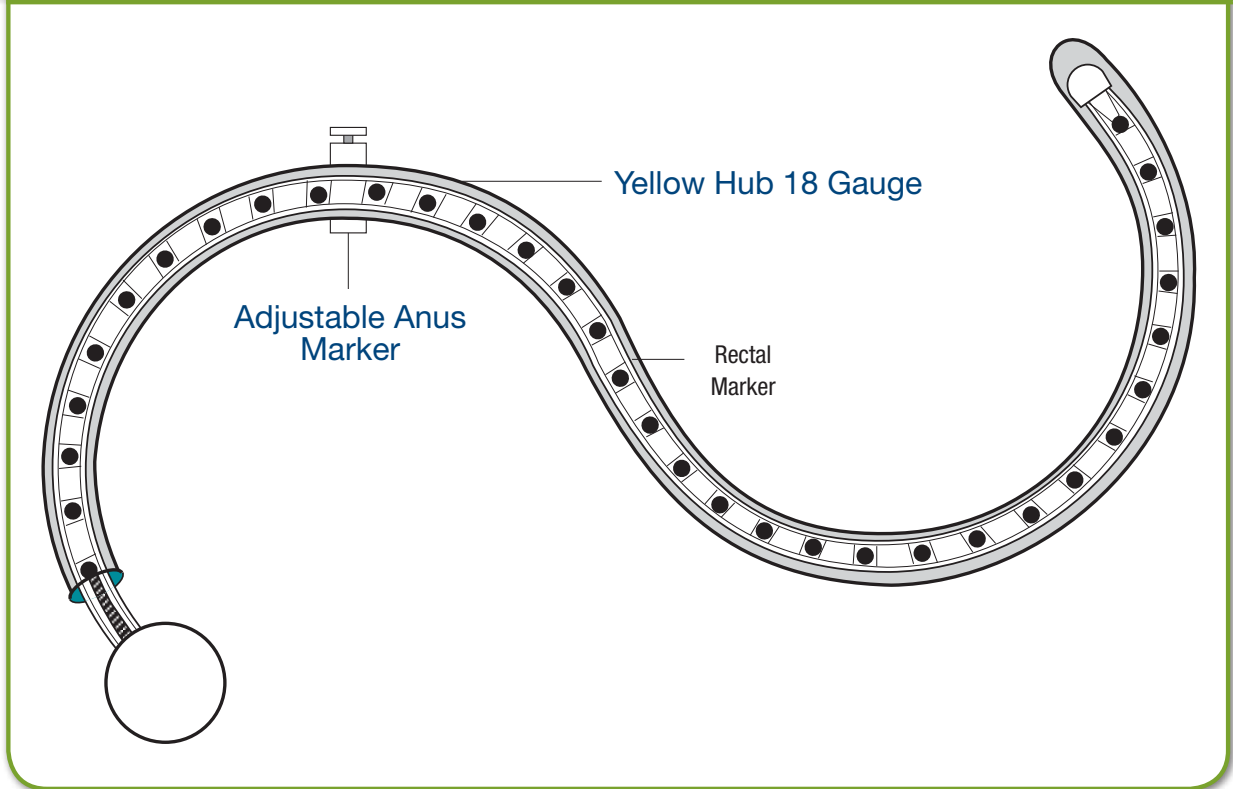

The Rectal Marker is a device generally used with localization fields on intracavitary (intrauterine-vaginal) applications or bladder external beam localizations.

With the old method of using a soldering or other type wire, one could only obtain the position of the rectum. But, with the Rectal Marker, it is now possible to obtain both position of rectum and magnification, which allows you to determine accurately the rectal distance from the radiation source.

### Also Available:

Disposable Rubber Sleeves for this product: Part # 1072-0009.

Part #	Rectal Marker is available with
222-1	Stainless Steel Ball
222-2	Tungsten Ball
960-1	Sterile Stainless Steel
960-2	Sterile Tungsten

**CAUTION:** This product should be carefully inspected by your staff prior to clinical use and should be used by authorized personnel only.



## Anderson Marker Kit

Part # 1074-0002



**Kit contains** a 25 cm long implanter (designed to limit implantation to 1 cm) and stylet.

## Adjustable Marker Kit

Part # 1074-0011

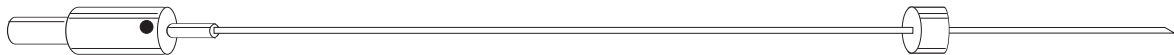

**Kit contains** a 20 cm long implanter with adjustable stop, stylet, one spare needle and one Allen wrench.

## Stainless Steel Markers

Part #

179-1

Markers are sold separately. The markers are easily identified on visualization films and also aid in treatment planning.

**NOTE:** Gold Markers (Part # 351) are also available to use with Anderson Marker Kit or Adjustable Marker Kit.

**CAUTION:** This product should be carefully inspected by your staff prior to clinical use and should be used by authorized personnel only.



# Best<sup>®</sup> medical international

## Radioactive Seeds



Best<sup>®</sup> Iodine-125 Seed



Best<sup>®</sup> Palladium-103 Seed

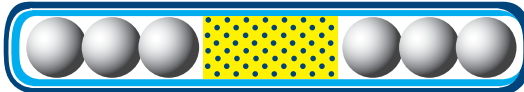

1 cm    5 mm seed    5 mm spacer

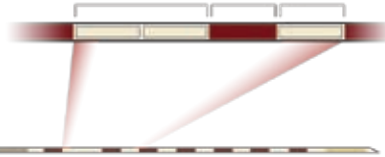

### Best® Iodine-125 Seed



#### Patented Double Wall Best® Iodine-125 Source

##### Part # 2301

Marker	Tungsten
Dose Rate Constant	NIST 1999 with 2000 Modification
External Length	5 mm (nominal) 1.02 cGy/hr/U
External Diameter	0.8 mm (nominal)

### Best® Palladium-103 Seed

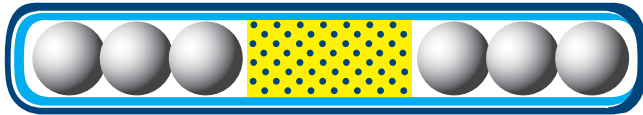

#### Patented Double Wall Best® Palladium-103 Source

##### Part # 2335

Marker	Tungsten
Dose Rate Constant	NIST 1999 with 2000 Modification
External Length	5 mm (nominal) 0.70 cGy/hr/U
External Diameter	0.8 mm (nominal)

- Patented double wall titanium encapsulation with uniform wall thickness
- Tungsten Marker—excellent images of source in ultrasound, X-ray, CT, MRI, and fluoro—far superior to other commercially available sources
- Source calibration traceable to NIST<sub>1999</sub> calibration revised for 2000
- Sources and spacers are the same length (5.0 mm nominal) and diameter (0.8 mm nominal), fitting Mick cartridge snugly
- Custom-made high quality spacers and Mick cartridges provided at no cost
- Sources can be provided as loose seeds; loaded in needles with spacers, sterile; loaded in strands, sterile; preloaded in Mick cartridges

#### References:

- 1) A.S. Meigooni, D.M. Gearheart, and K. Sowards, Med. Phys. 27, 2168-2173 (2000)
- 2) S.W. Peterson and B. Thomadsen, Brachytherapy 1, 110-119 (2002)
- 3) R. Nath and N. Yue, Brachytherapy, 1, 102-109 (2002)

**24hours**

Available from Best® within 24 hours:  
Best® I-125 and Pd-103 seeds in sterile packing



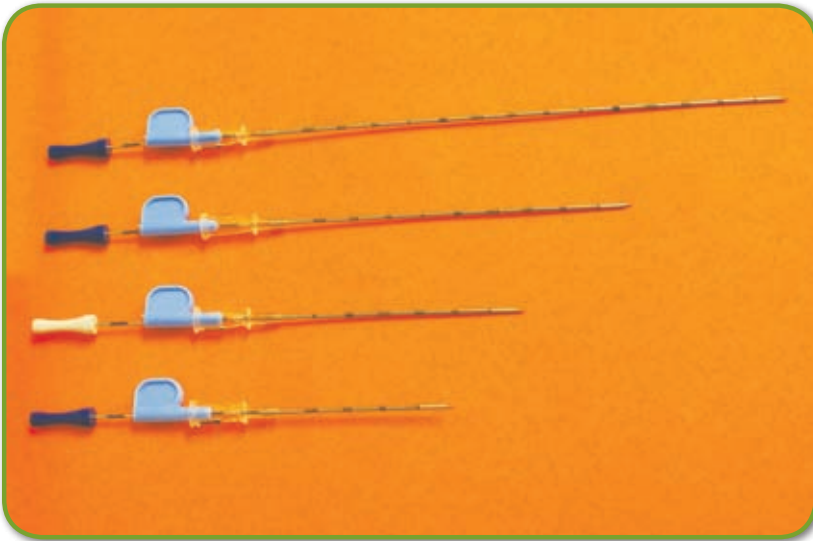

## Breast Localization Needles with Iodine-125 Seeds

Part #	Description
10172-8	5 cm Length
10172-11	7 cm Length
10172-02	10 cm Length
10172-05	15 cm Length

- Available in all ranges of seed activities (0.08 to 0.4 mCi) with a shelf life of 90 days
- Needles are supplied sterile and are individually packaged and shielded
- Best localization needles with Iodine-125 seeds are FDA approved

## I-125

### Single Needle with Single Source Part Numbers

Part #	Description
10172-2	I-125 Loose Source (single) in 18 Gauge x 10cm Needle
10172-5	I-125 Loose Source (single) in 18 Gauge x 15cm Needle
10172-8	I-125 Loose Source (single) in 18 Gauge x 5cm Needle
10172-11	I-125 Loose Source (single) in 18 Gauge x 7cm Needle
10172-14	I-125 Single Source in Strand in 18 Gauge x 5cm Needle
10172-17	I-125 Single Source in Strand in 18 Gauge x 7cm Needle
10172-20	I-125 Single Source in Strand in 18 Gauge x 10cm Needle
10172-23	I-125 Single Source in Strand in 18 Gauge x 15cm Needle

# 24hours

Available from Best<sup>®</sup> within 24 hours:  
Best<sup>®</sup> I-125 and Pd-103 seeds in sterile packing



**I-125****Sterile & Non-Sterile Seed Products**

Part #	Description
10113	Loose (non-sterile)
10113-21	Loose (sterile)
10165-3	Strands in Needles (in plastic tray)
10165-4	Loose Sources in Needles (in plastic tray)
10165-17	Loose and Stranded Sources in Needles (in plastic tray)
10165-1	Stylets in Tubes
10113-23	Cartridge with Sources (non-sterile)
10113-11	Cartridge with Sources (sterile)
10176-13	Best Cartridge with Sources
10117-5	Reusable Cartridges with Sources
10120-1	Strands in Needles (in Best new tray)
10120-3	Loose Sources in Needles (in Best new tray)
10120-5	Loose and Stranded Sources in Needles (in Best new tray)

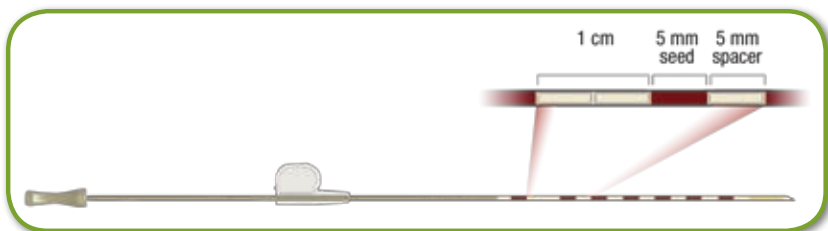

# 24hours

Available from Best® within 24 hours:  
Best® I-125 and Pd-103 seeds in sterile packing





- Patented double wall titanium encapsulation with uniform wall thickness
- Best<sup>®</sup> custom strand (per your prescription)
- Best<sup>®</sup> standard strand (10 seeds/strand spaced 1 cm apart)
- Best<sup>®</sup> real-time strand/needle (use our loader in the OR)
- Best<sup>®</sup> seeds and spacers in pre-loaded needles
- Cartridges
- Loose seeds

Pd-103	
Sterile & Non-Sterile Seed Products	
Part #	Description
15113	Loose Pd-103 Source (non-sterile)
15113-11	Vial with Pd-103 Sources in a Pouch (sterile)
15165-1	Pd-103 Strand (in a pack)
15165-4	Needle with Pd-103 Loose Sources Assembly (in a plastic tray)
15165-9	Needle with Pd-103 Sources in Strands Assembly (in a plastic tray)
15165-11	Needle with Pd-103 Loose Sources and Strands Assembly (in a plastic tray)
15113-13	Pd-103 Sources in Cartridge (non-sterile)
15113-14	Pd-103 Sources in Cartridge (sterile)
15180-1	Needle with Pd-103 Loose Sources Assembly (in Best tray)
15180-3	Needle with Pd-103 Sources in Strands Assembly (in Best tray)
15180-5	Needle with Pd-103 Loose Sources and Strands Assembly (in a tray)

## 24hours

Available from Best<sup>®</sup> within 24 hours:  
Best<sup>®</sup> I-125 and Pd-103 seeds in sterile packing

<b>Iridium-192</b>	
<b>Part # 118</b>	
<b>Ir-192 Seeds in Nylon Ribbons</b>	
Range of Activity	0.1 to 10 mg Raeq per Seed
Seed Dimension	3.0 mm Long and 0.5 mm Diameter
Emission Energy	0.37 MeV (average) Gamma Energy
0.1 mm Diameter	Core of 30% Ir & 70% Pt Surrounded by 0.2 mm Thick Stainless Steel Wall
Physical Characteristics	1. Half-life 74.3 Days 2. HVL (50% attenuation) About 3 mm Lead 3. Specific Gamma Ray Constant 4.6 R cm <sup>2</sup> /mCi/hr
<b>Custom Spacing Available.</b>	

<b>Gold-198</b>	
<b>Part # 557</b>	
<b>Au-198</b>	
Range of Activity	0.1 to 10 mCi per Seed (4.7 mCi of Gold-198 is Equal to 1 mCi of Radon)
Seed Dimension	2.5 mm long and 0.8 mm Diameter
Emission Energy	420 keV (average) Gamma Rays
Construction	Metallic Gold Pellet Encapsulated in Platinum
Physical Characteristics	1. Half-life 2.7 days 2. HVL (50% attenuation) About 4 mm Lead 3. Specific Gamma Ray Constant 2.35 R cm <sup>2</sup> /mCi/hr
<b>Custom Activities Available.</b>	

- We are the only one to provide comparative calibration data traceable to NIST, Washington, DC, University of Wisconsin, K&S Associates, and M.D. Anderson Hospital, Houston, TX, for the past 15 years — which indicates excellent quality control.
- We are the only supplier of LDR Iridium-192 and Gold-198 seeds.
- We are the only provider of Iridium-192 in nylon ribbons in a wide range of activities.
- We are the only one to provide custom services for Gold-198 permanent implants, as well as a wide range of activities.
- We are the first and only one to call our customers the morning after shipping to inform them of mode of transportation and expected arrival time.



Co-57 Nuclear Medicine Products			
Part #	Case	Configuration	Size
<b>Flood Source</b>			
5302-2416-10*-S	With Case	Rectangle	24" X 16"
5302-2416-15*-S	With Case		
5302-2416-20*-S	With Case		
5302-2416-10*	Without Case	Rectangle	24" X 16"
5302-2416-15*	Without Case		
5302-2416-20*	Without Case		



Best Medical International now offers durable highly uniform Co-57 Flood Sources for gamma camera quality control. Common rectangular and round configurations are available from inventory, as well as custom sizes. All Flood Sources are measured to ensure a coefficient of variation of less than 1% and certified in accordance with ANSI N42.27-1999. Each Flood Source is provided in a shielded storage case.

**Other flood sizes available upon request**

*\* activity*

*continues on next page*

<i>Part #</i>	<i>Case</i>	<i>Configuration</i>	<i>Size</i>
<b>Flood Source</b>			
5302-1814-5*-S	With Case	Rectangle	18" X 14"
5302-1814-10*-S	With Case		
5302-1814-15*-S	With Case		
5302-1814-20*-S	With Case		
5302-1814-5*	Without Case	Rectangle	18" X 14"
5302-1814-10*	Without Case		
5302-1814-15*	Without Case		
5302-1814-20*	Without Case		
5302-1610-5*-S	With Case	Rectangle	16" X 10"
5302-1610-7.5*-S	With Case		
5302-1610-10*-S	With Case		
5302-1610-5*	Without Case	Rectangle	16" X 10"
5302-1610-7.5*	Without Case		
5302-1610-10*	Without Case		
5302-1111-5*-S	With Case	Rectangle	11" X 11"
5302-1111-10*-S	With Case		
5302-1111-5*	Without Case	Rectangle	11" X 11"
5302-1111-10*	Without Case		
5303-18-10*-S	With Case	Round	18"
5303-18-15*-S	With Case		
5303-18-20*-S	With Case		
5303-18-10*	Without Case	Round	18"
5303-18-15*	Without Case		
5303-18-20*	Without Case		
5303-24-10*-S	With Case	Round	24"
5303-24-15*-S	With Case		
5303-24-20*-S	With Case		
5303-24-10*	Without Case	Round	24"
5303-24-15*	Without Case		
5303-24-20*	Without Case		

**Other flood sizes available upon request.**

*continues on next page*

\* activity



<i>Part #</i>	<i>Isotope</i>
<b>Dose Calibrator Vials</b>	
5301-1-5	Co-57
5301-1-10	
5301-2-100	Cs-137
5301-2-200	

**Call and check for availability.**

<i>Part #</i>	<i>Isotope</i>
<b>Markers and Rulers</b>	
5304-50	Co-57
5304-100	
5304-200	
5305-100	Co-57
5305-200	
5306-230	Co-57
5306-460	
5307-80	Co-57
5307-160	

**Call and check for availability.**



# Best<sup>®</sup> medical *international*

## Stainless Steel Needles

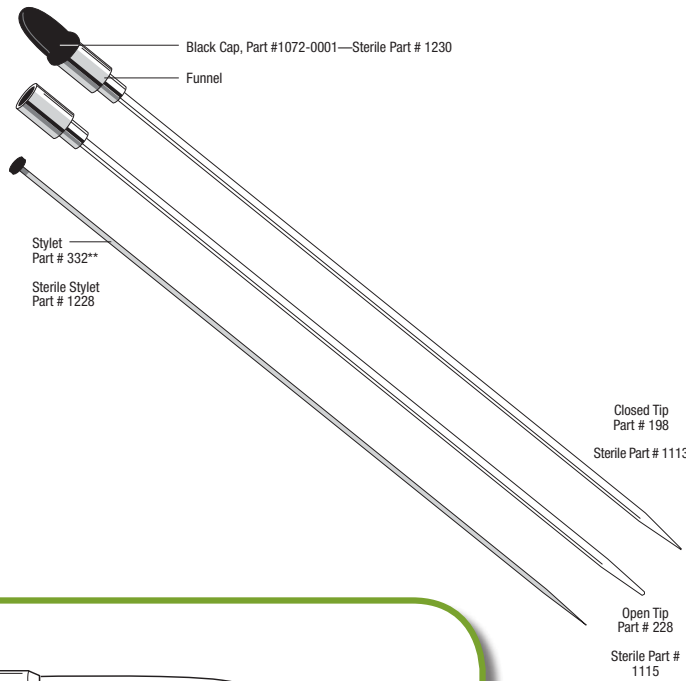
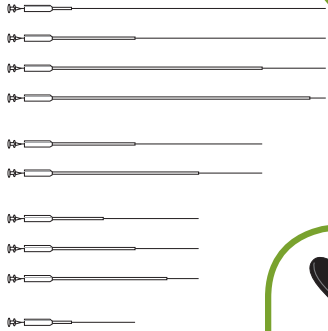

Long: 5004-0002



Short: 5004-0001

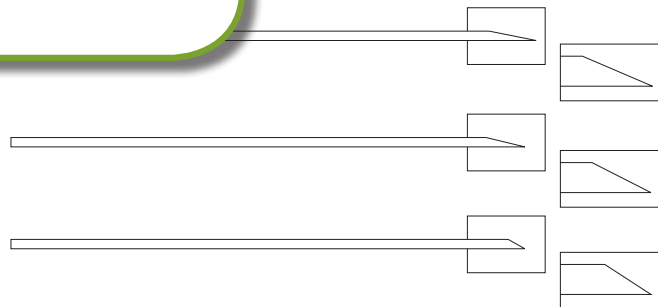



## Implant Needles

### A Bevel

17G  
Available in 10 cm, 15 cm, and 20 cm

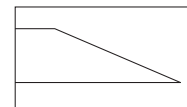
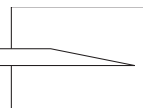

### B Bevel Sterile Part #

17G 1076  
14G 1333  
Available in 10 cm, 15 cm, 20 cm, and 25 cm

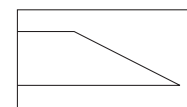
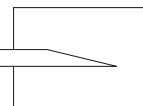

### C Bevel Sterile Part #

17G 1458  
14G  
Available in 10 cm, 15 cm, 20 cm, and 25 cm  
\* 25 cm length only available in 17G

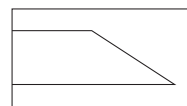
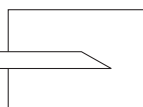

The Implant Needles are made of Stainless Steel and are hollow with different types of bevel at one end. Various lengths in different gauges are available, though the most commonly used needle is the 17G. Different types of Implant Needles are listed below:

	<i>A Bevel Part #</i>	<i>B Bevel Part #</i>	<i>C Bevel Part #</i>
17G 10 cm	A-203-10	B-202-10	C-201-10
17G 15 cm	A-203-15	B-202-15	C-201-15
17G 20 cm	A-203-20	B-202-20	C-201-20
17G 25 cm		B-202-25	C-201-25
14G 10 cm		B-200-10	C-199-10
14G 15 cm		B-200-15	C-199-15
14G 20 cm		B-200-20	C-199-20
<b>Custom length is available upon request.</b>			

**CAUTION:** This product should be carefully inspected by your staff prior to clinical use and should be used by authorized personnel only.



### Curved Needles

These are curved Stainless Steel Implant Needles with handle. The outer diameter (O.D.) is 0.095" and the inner diameter (I.D.) is 0.077". Two sizes are available: short and long. The short needle has a length of 3.5" and the long needle measures 7.25". Each handle is 4" long.

**Also available:** Thin wall curved short needles

#### Part # 5004-0002-Long

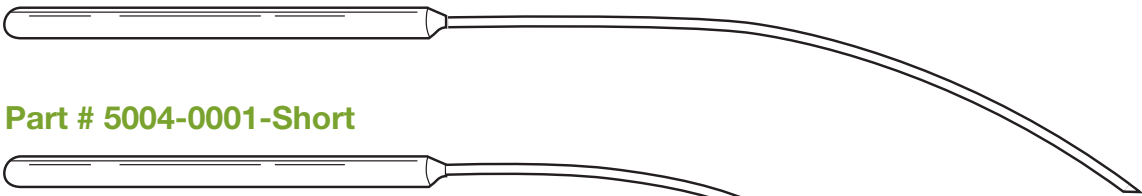

#### Part # 5004-0001-Short



**CAUTION:** This product should be carefully inspected by your staff prior to clinical use and should be used by authorized personnel only.

## Template Needles with Funnel and Cap



This 20 cm needle is specifically designed for use with Syed/Neblett templates or disposable templates. A funnel fixed to one end makes the ribbon loading easy and less time consuming. A special cap fits over the funnel to keep the ribbon in position.

**Custom length is available upon request.**

**Caps are for one time use only.**

**CAUTION:** This product should be carefully inspected by your staff prior to clinical use and should be used by authorized personnel only.



**Template Needles**

**Template Needles, 17G**

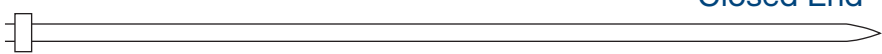
**With Collar**  Closed End

Open Tip. . . . . Part # 227-Length  
 Sterile Open End . . . . . Part # 1395  
 Sterile Closed End . . . . . Part # 1397

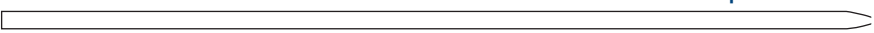
**Without Collar**  Tapered End

. . . . . Part # 196  
 Sterile Open End . . . . . Part # 1226  
 Sterile Closed End . . . . . Part # 1224

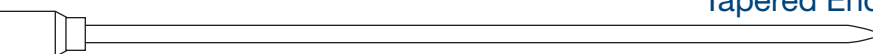
**Without Funnel**  Tapered End

Closed Tip . . . . . Part # 198    Sterile . . . . . Part # 1113  
 Open Tip. . . . . Part # 228    Sterile . . . . . Part # 1115

These 17 Gauge Needles are used with the templates, which improve the homogeneity of radiation. Needles of different lengths, closed end or open end, with or without collar, with or without funnel, are available. Catalog numbers of different template needles are given below:

<i>Tapered End</i>	<i>Closed End</i>
Tapered without Collar 10 cm, 15 cm, 20 cm, 25 cm Part # 196.....Part # 1226	Closed in with Collar 10 cm, 15 cm, 20 cm, 25 cm Part # 197.....Part # 1397
Tapered with Collar 10 cm, 15 cm, 20 cm, 25 cm Part # 227.....Part # 1395	Closed in without Collar 10 cm, 15 cm, 20 cm Part # 193.....Part # 1224
Template Needle with Funnel & Tapered End 20 cm Part # 228.....Part # 1115 Stylet for the Above Part # 332.....Part # 1228	Template Needle (pencil point or sharp) with Funnel & Closed Tip 20 cm Part # 198.....Part # 1113

**CAUTION:** This product should be carefully inspected by your staff prior to clinical use and should be used by authorized personnel only.

## Needle Implanters

Four Inch Implanter	— 2 inch point. . . . .	Part # 1074-0016
Six Inch Implanter	— 1 inch point. . . . .	Part # 1074-0017
Six Inch Implanter	— 2 inch point. . . . .	Part # 1074-0019
Six Inch Implanter	— 4 inch point. . . . .	Part # 1074-0020
Eight Inch Implanter	— 2 inch point. . . . .	Part # 1074-0022
Eight Inch Implanter	— 4 inch point. . . . .	Part # 1074-0023
Ten Inch Implanter	— 1 cm point . . . . .	Part # 1074-0031
Ten Inch Implanter	— 2 inch point. . . . .	Part # 1074-0024
Ten Inch Implanter	— 6 inch point. . . . .	Part # 1074-0025
Ten Inch Implanter	— 8 inch point. . . . .	Part # 1074-0026

**\*Other implanters also available.**

**CAUTION:** This product should be carefully inspected by your staff prior to clinical use and should be used by authorized personnel only.



## Diddler-Needle Adjustment Tool

Part # 5002-0010

### Use the DIDDLER, Not Your Fingers!

The DIDDLER is a device to adjust the position of transperineal prostate seeding needles during the time of seed implantation. Often, fingers are needed to reach behind the transperineal template to readjust the needle position. The DIDDLER replaces the need to use fingers which, in most cases, are too big to reach a needle between the template and perineum.

The DIDDLER, similar in construction to a crochet needle, is made entirely of stainless steel and consists of a long hexagonally shaped handle with a slender tip. The tip thus allows a needle to be pushed, pulled or twisted left and right even if there is a needle right next to it.

**Adjust the needle up, down and sideways without using your fingers!**

### Radiation Protection

The DIDDLER is especially effective when needle repositioning with "HOT" Pre-loaded Prostate Seeding Needles is required. Notably, the DIDDLER is most useful in the Mick technique when numerous needles are implanted either peripherally, in rows, or all at once.

The DIDDLER is approximately 8" (20 cm) long and made entirely of stainless steel. A high-polish finish provides for easy cleaning and flash sterilization.

**The DIDDLER can be AUTOCLAVED!**

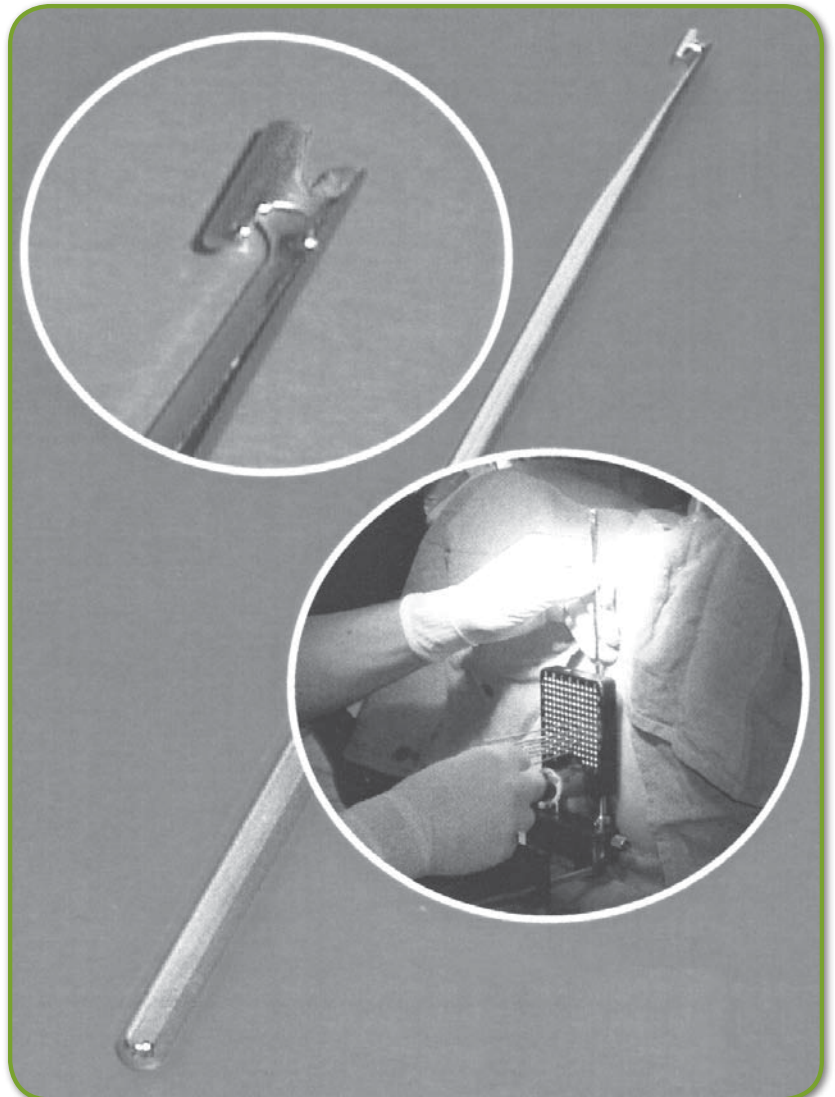

### Specifications:

Material	Stainless Steel
Length	8" (20 cm approximately)
Size	(6.4 mm diameter) Hexagonal Stock

**CAUTION:** This product should be carefully inspected by your staff prior to clinical use and should be used by authorized personnel only.



# Best<sup>®</sup> medical *international*

## Templates

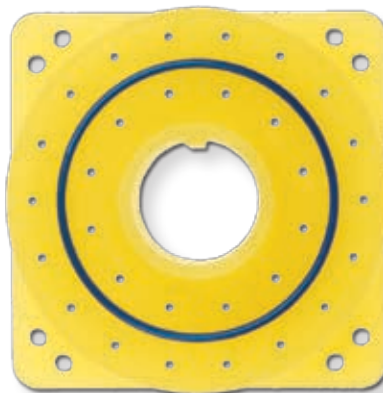
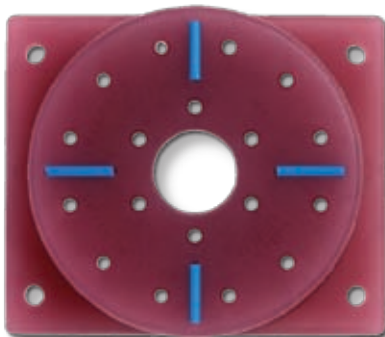
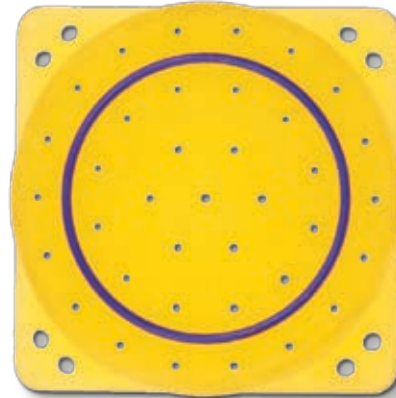



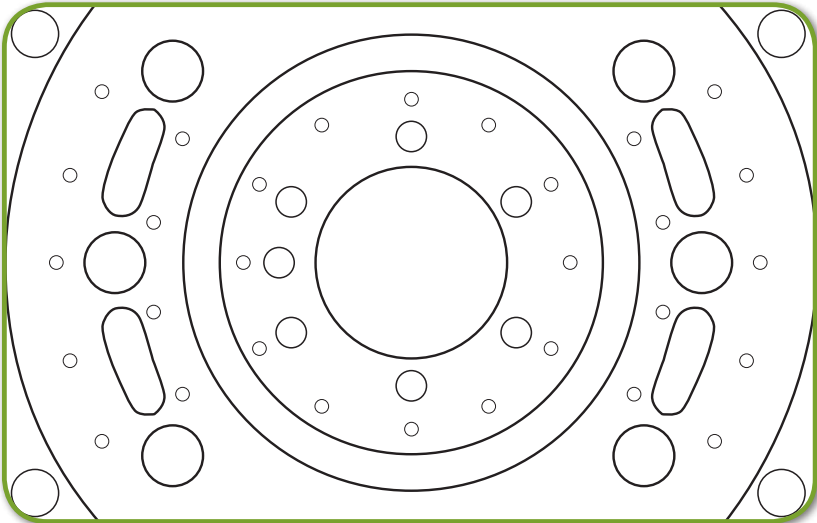
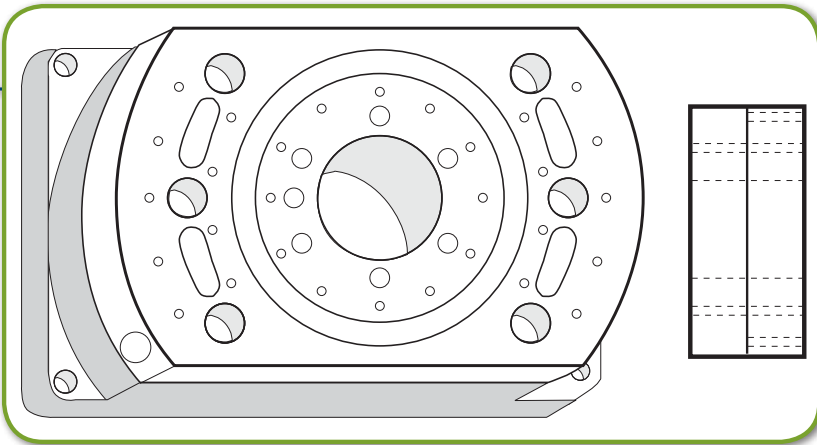

**Hole Pattern**

**17G Syed/Neblett Gyn Template #1**

*Part # 1246-1 (sterile )*

*Part # 214-1 (non-sterile)*

**15G Syed/Neblett Gyn Template #1**

*Part # 1246-3 (sterile)*

*Part # 214-3 (non-sterile)*

**With:**

1	Template
1	15 cm Central Rod
2	Wrenches
1	Stainless Steel Ruler
1	Magnification Ring
	Extra 'O' Rings, Screws and Cap

**Syed/Neblett GynTemplate Kit #1**

*Part # 1246-2 (sterile)*

*Part # 214-2 (non-sterile)*

**Kit contains:**

1	Template
1	15 cm Central Rod
36	Needles with Funnels
5	Needles without Funnels
1	Magnification Ring
2	Wrenches
10	Stylets
1	Stainless Steel Ruler
	Extra 'O' Rings, Screws and Cap
	<b>Optional:</b> Storage Tray

**NOTE:** Specify hole size when ordering (15 gauge or 17 gauge).

**CAUTION:** This product should be carefully inspected by your staff prior to clinical use and should be used by authorized personnel only.



## 17G Syed/Neblett Gyn Template #2

Part # 1248-1 (sterile)

Part # 215-1 (non-sterile)

## 15G Syed/Neblett Gyn Template #2

Part # 1248-3 (sterile)

Part # 215-3 (non-sterile)

### With:

1	Template
1	15 cm Central Rod
2	Wrenches
1	Stainless Steel Ruler
1	Magnification Ring
	Extra 'O' Rings, Screws and Cap

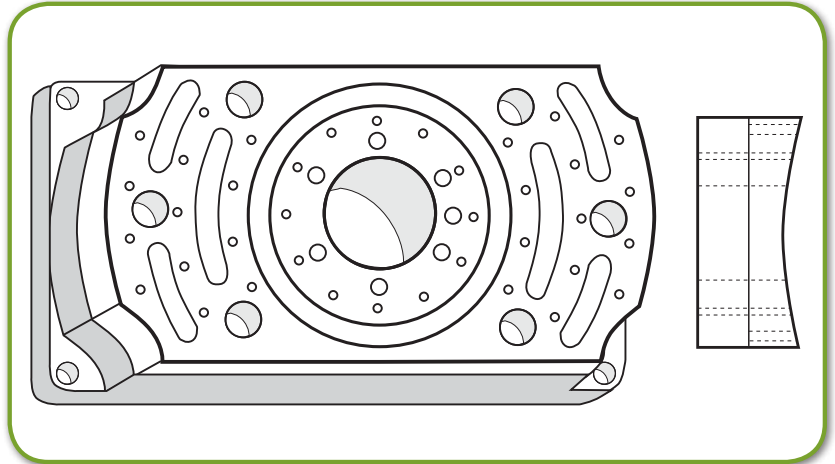

## 17G Syed/Neblett Gyn Template Kit #2

Part # 1248-2 (sterile)

Part # 215-2 (non-sterile)

### Kit contains:

1	Template
1	15 cm Central Rod
45	Needles with Funnels
5	Needles without Funnels
1	Magnification Ring
2	Wrenches
10	Stylets
1	Stainless Steel Ruler
	Extra 'O' Rings, Screws and Cap
	<b>Optional:</b> Storage Tray

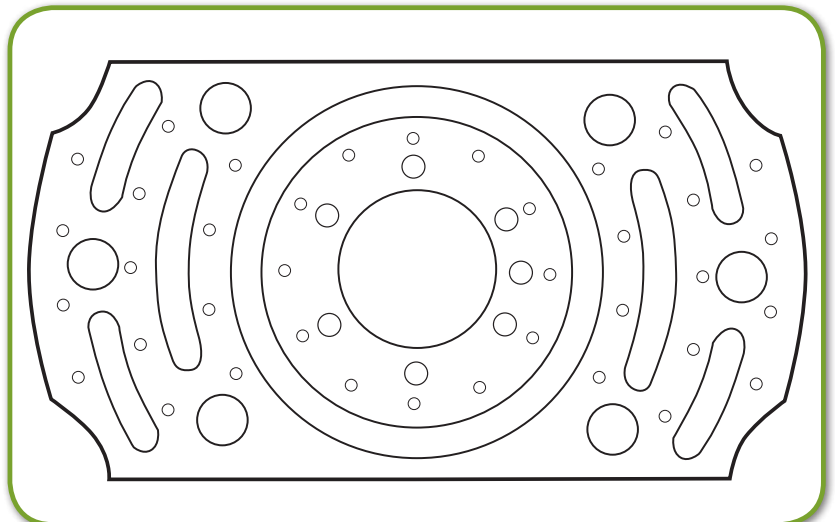

**Hole Pattern**

**NOTE:** Specify hole size when ordering (15 gauge or 17 gauge).

**CAUTION:** This product should be carefully inspected by your staff prior to clinical use and should be used by authorized personnel only.

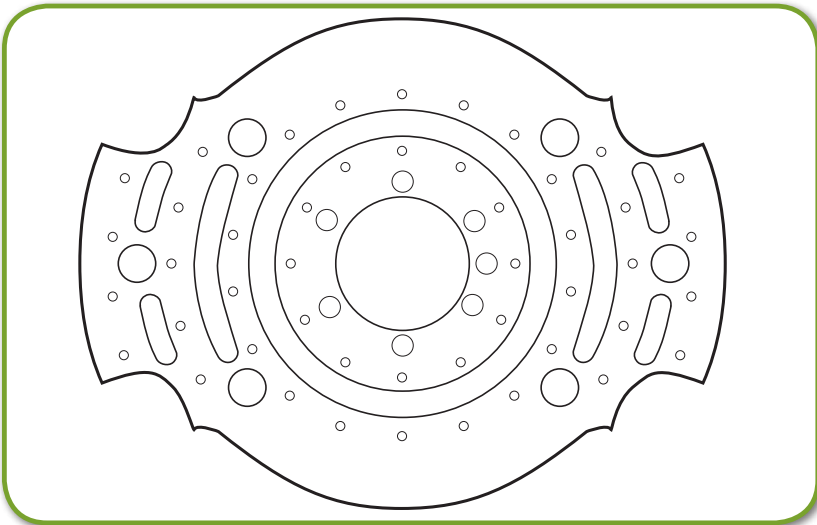
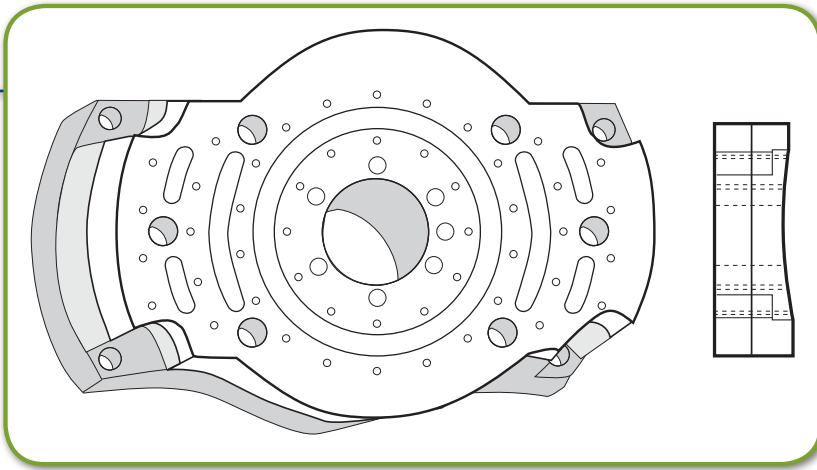

**Hole Pattern**

**17G Syed/Neblett Gyn Template #3**

*Part # 1250-1 (sterile)*

*Part # 216-1 (non-sterile)*

**15G Syed/Neblett Gyn Template #3**

*Part # 1250-3 (sterile)*

*Part # 216-3 (non-sterile)*

**With:**

1	Template
1	15 cm Central Rod
2	Wrenches
1	Stainless Steel Ruler
1	Magnification Ring
	Extra 'O' Rings, Screws and Cap

**17G Syed/Neblett Gyn Template Kit #3**

*Part # 1250-2 (sterile)*

*Part # 216-2 (non-sterile)*

**Kit contains:**

1	Template
1	15 cm Central Rod
55	Needles with Funnels
5	Needles without Funnels
1	Magnification Ring
2	Wrenches
10	Stylets
1	Stainless Steel Ruler
	Extra 'O' Rings, Screws and Cap

**NOTE:** Specify hole size when ordering (15 gauge or 17 gauge).

**CAUTION:** This product should be carefully inspected by your staff prior to clinical use and should be used by authorized personnel only.



## 17G Syed/Neblett Prostate Template

Part # 1260-1 (sterile)

Part # 159-1 (non-sterile)

## 15G Syed/Neblett Prostate Template

Part # 1260-3 (sterile)

Part # 159-3 (non-Sterile)

### With:

1	Template
1	Wrench
	Extra 'O' Rings and Screws

## 17G Syed/Neblett Prostate Template Kit

Part # 1260-2 (sterile)

Part # 159-2 (non-sterile)

### Kit contains:

1	Template
18	Needles with Funnels
3	Needles without Funnels
1	Wrench
5	Stylets
1	Stainless Steel Ruler
	Extra 'O' Rings, Screws and Cap
	<b>Optional:</b> Storage Tray

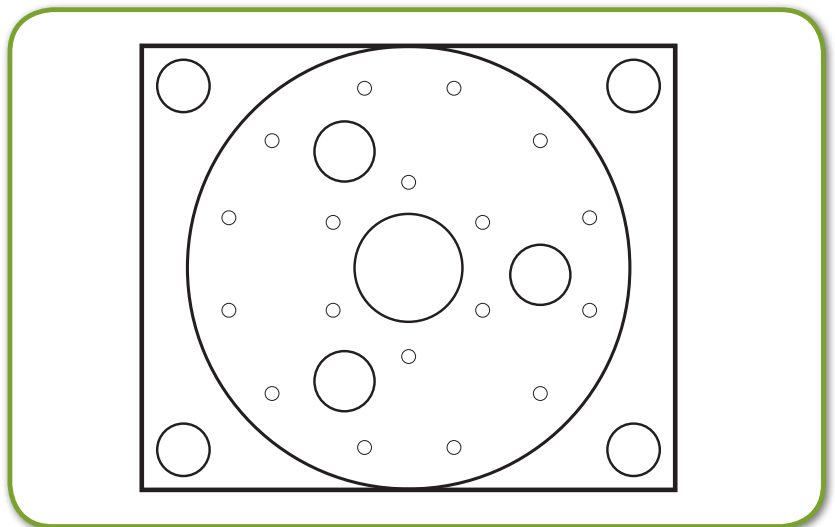
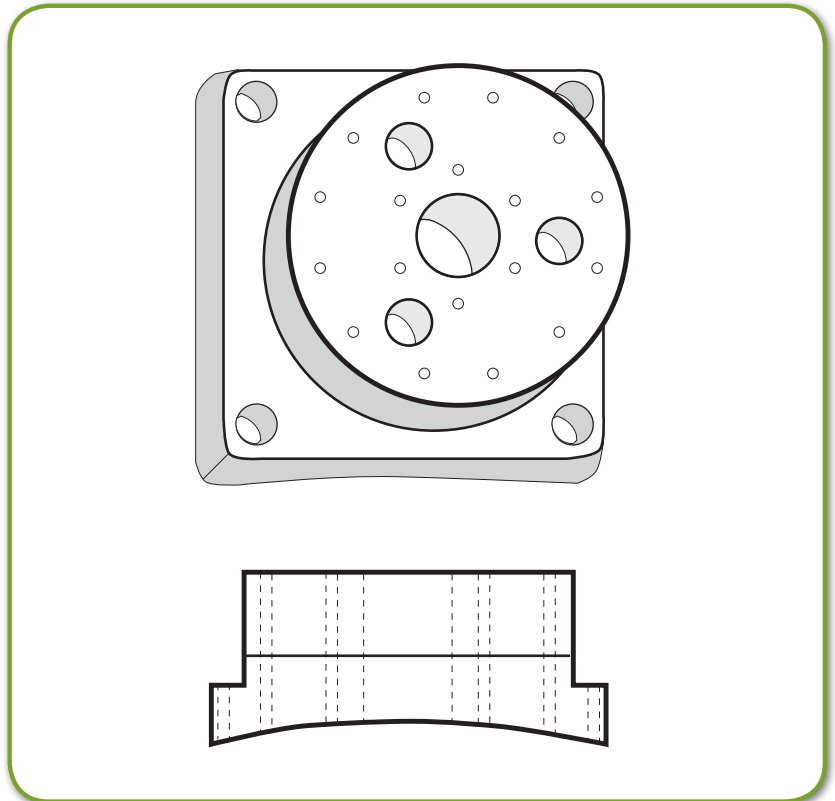

**Hole Pattern**

**NOTE:** Specify hole size when ordering (15 gauge or 17 gauge).

**CAUTION:** This product should be carefully inspected by your staff prior to clinical use and should be used by authorized personnel only.

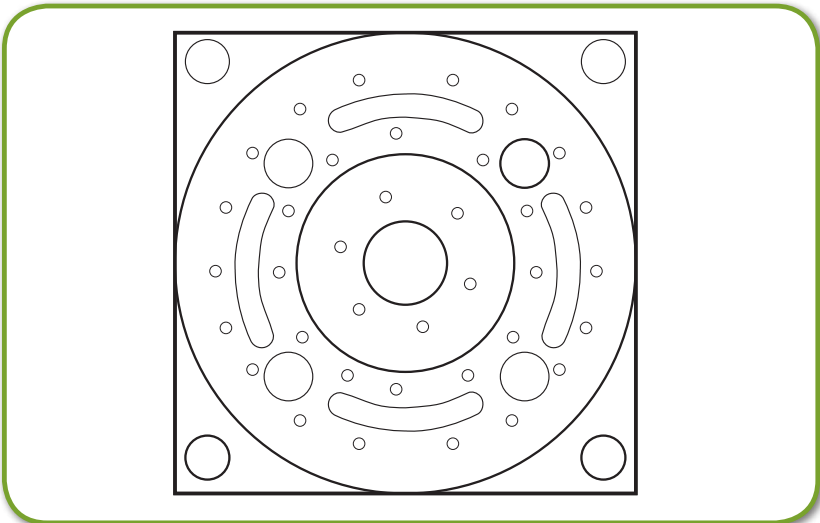
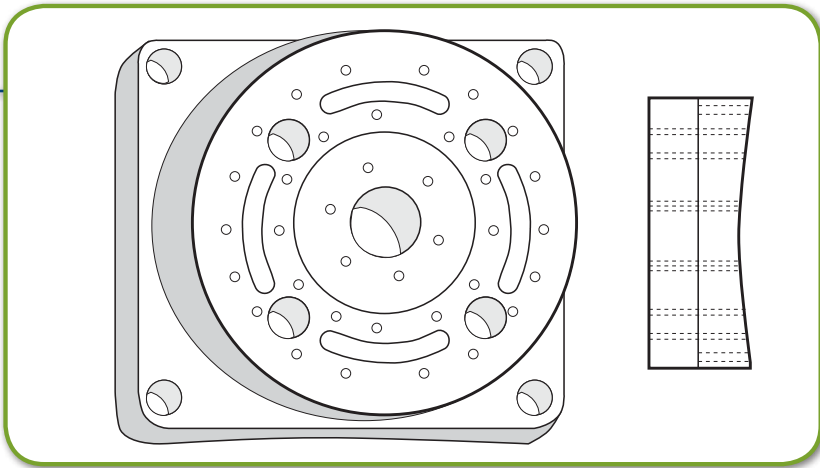

**Hole Pattern**

**17G Syed/Neblett Rectal Template**

*Part # 1256-1 (sterile)*

*Part # 236-1 (non-sterile)*

**15G Syed/Neblett Rectal Template**

*Part # 1256-3 (sterile)*

*Part # 236-3 (non-sterile)*

**With:**

1	Template
1	Wrench
	Extra 'O' Rings and Screws

**Syed/Neblett Rectal Template Kit**

*Part # 1256-2 (sterile)*

*Part # 236-2 (non-sterile)*

**Kit contains:**

1	Template
36	Needles with Funnels
3	Needles without Funnels
1	Wrench
1	Stainless Steel Ruler
	Extra 'O' Rings, Screws and Cap

**NOTE:** Specify hole size when ordering (15 gauge or 17 gauge).

**CAUTION:** This product should be carefully inspected by your staff prior to clinical use and should be used by authorized personnel only.



## 17G Syed/Neblett Urethral Template

Part # 1264-1 (sterile)

Part # 237-1 (non-sterile)

## 15G Syed/Neblett Urethral Template

Part # 1264-3 (Sterile)

Part # 237-3 (Non-sterile)

### With:

1	Template
1	Wrench
	Extra 'O' Rings, Screws and Cap

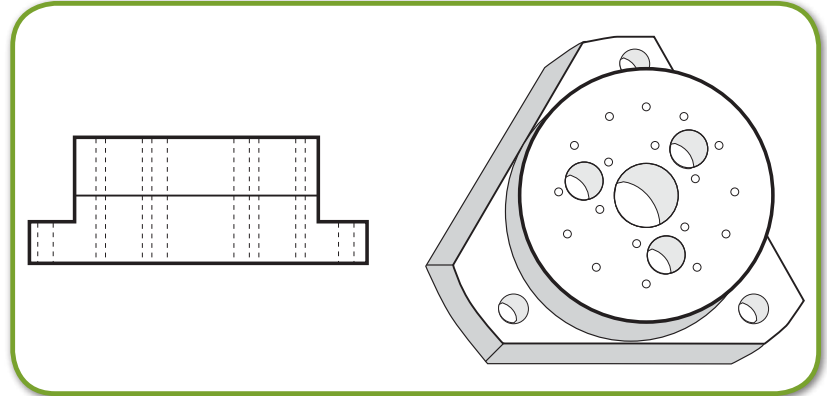

## 17G Syed/Neblett Urethral Template Kit

Part # 1264-2 (sterile)

Part # 237-2 (non-sterile)

### Kit contains:

1	Template
18	Needles with Funnels
2	Needles without Funnels
1	Wrench
5	Stylets
1	Stainless Steel Ruler
	Extra 'O' Rings, Screws and Cap
	<b>Optional:</b> Storage Tray

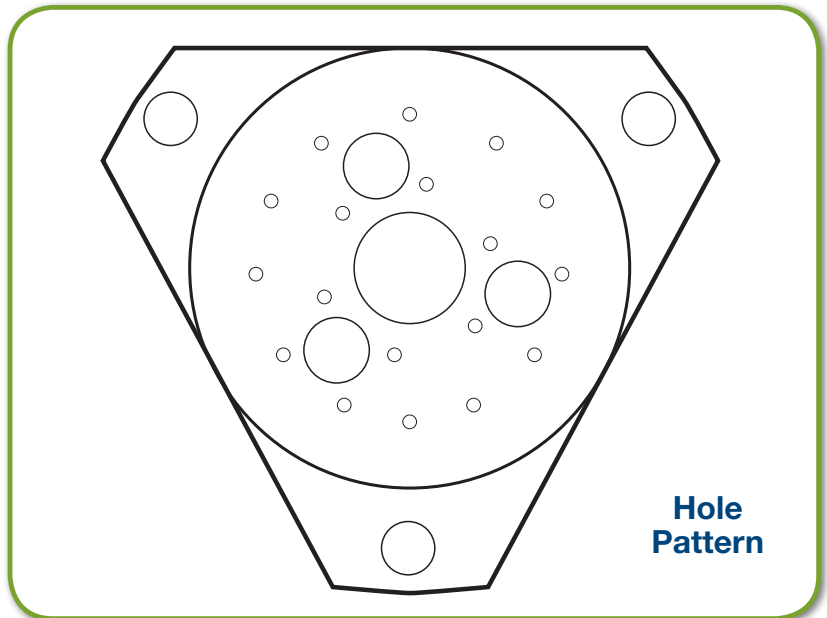

Hole  
Pattern

**NOTE:** Specify hole size when ordering (15 gauge or 17 gauge).

**CAUTION:** This product should be carefully inspected by your staff prior to clinical use and should be used by authorized personnel only.



<b>17G Disposable GYN Template Kit</b>	
<i>Part # 350-1 (non-sterile)</i>	
<b>Kit contains:</b>	
1	Template
1	15 cm Central Rod
1	Wrench
1	Sleeve
1	'O' Ring

<b>Sterile Disposable GYN Template Kit</b>	
<i>Part # 350-2 Green in a Pouch</i>	
<b>Kit contains:</b>	
290-2	Template
779	Accessories

<b>Non-sterile Template Only</b>	
<b>Part #</b>	
778	17G
474	15G

<b>Sterile Template Kit 15G</b>	
<i>Part # 790</i>	
<b>Kit contains:</b>	
788	Template
789	Accessories

**NOTE:** Specify hole size when ordering (15 gauge or 17 gauge).

**CAUTION:** This product should be carefully inspected by your staff prior to clinical use and should be used by authorized personnel only.



Sterile GYN Template	
<b>Part #</b>	
290-2	Green in a Pouch

Non-Sterile Disposable GYN Purple Template Kit	
<b>Part #</b>	
691	1.9 mm

17G Sterile Accessories Template	
<b>Part #</b>	
779	In a Pouch

15G Sterile Disposable GYN Purple Template Kit	
<b>Part #</b>	<b>Kit contains:</b>
788	Template In a Pouch
789	Accessories in a Pouch
790	Complete Kit

15G Sterile Accessories Template	
<b>Part #</b>	
789	In a Pouch

16G Sterile Disposable GYN Template	
<b>Part #</b>	
1474-2	Green

16G Sterile Accessories Template	
<b>Part #</b>	
1476	In a Pouch

16G Sterile Disposable GYN Template Kit	
<b>Part #</b>	
1478-2	Green

15.5G Disposable GYN Template	
<b>Part #</b>	
1736	In a Pouch

15.5G Sterilized Disposable GYN Template Kit	
<b>Part #</b>	
1738	Complete Kit

**NOTE:** Specify hole size when ordering (15 gauge or 17 gauge).

**CAUTION:** This product should be carefully inspected by your staff prior to clinical use and should be used by authorized personnel only.



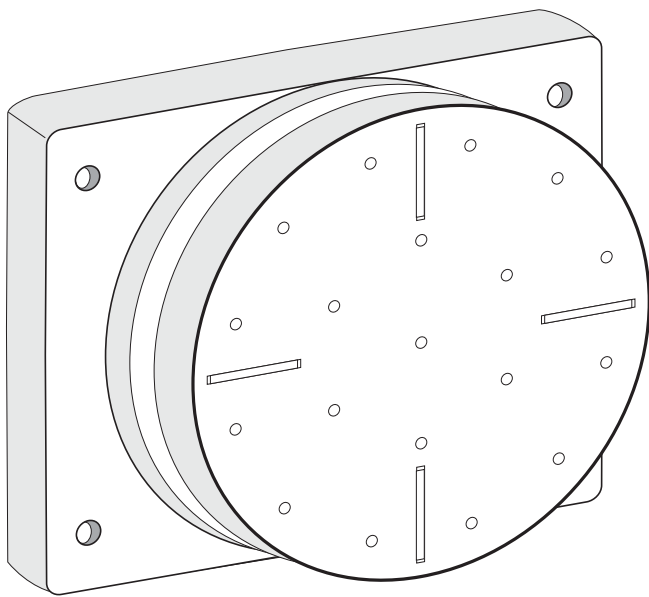
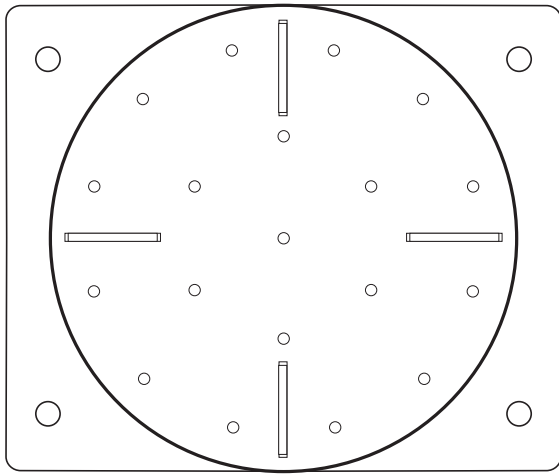

This disposable prostate template is made of Medical Grade Silicone Elastomer. The hole pattern is as shown in the figure.

**This disposable template is for one time use only.**

### 17G Disposable Prostate Template Kit (with needle hole)

Part #	
223-1	Non-sterile
1184	Sterile

**NEEDLES:** 17 gauge flexi-needles or 17 gauge stainless steel needles could be used.

If you find difficulty in pushing the needles through the holes, dip needle in appropriate lubricant and use.

### 15G Disposable Prostate Template (needle hole in a pouch)

Part #	
1740	Sterile
223-4	Non-sterile

**NEEDLES:** Only 15 gauge flexi-needles or can be used with this template. If you find difficulty in pushing the needles through the holes, dip needle in appropriate lubricant and use.

**CAUTION:** This product should be carefully inspected by your staff prior to clinical use and should be used by authorized personnel only.



## 17G Disposable Prostate Template (with small hole)

Part #	
473-1	Non-sterile
1186	Sterile

**NEEDLES:** 17 gauge flexi-needles or 17 gauge stainless steel needles could be used.

If you find difficulty in pushing the needles through the holes, dip needle in appropriate lubricant and use.

## 15G Prostate Template

Part #	
776-2	Non-sterile
726-2	Sterile

**NEEDLES:** 15 gauge flexi-needles or 15 gauge stainless steel needles could be used.

If you find difficulty in pushing the needles through the holes, dip needle in appropriate lubricant and use.

## 0.0555" Needle Hole Prostate Template Blue

Part #	
1853	Non-sterile
1857	Sterile

**NEEDLES:** 0.0555" flexi-needles or 0.0555" gauge stainless steel needles could be used.

If you find difficulty in pushing the needles through the holes, dip needle in appropriate lubricant and use.

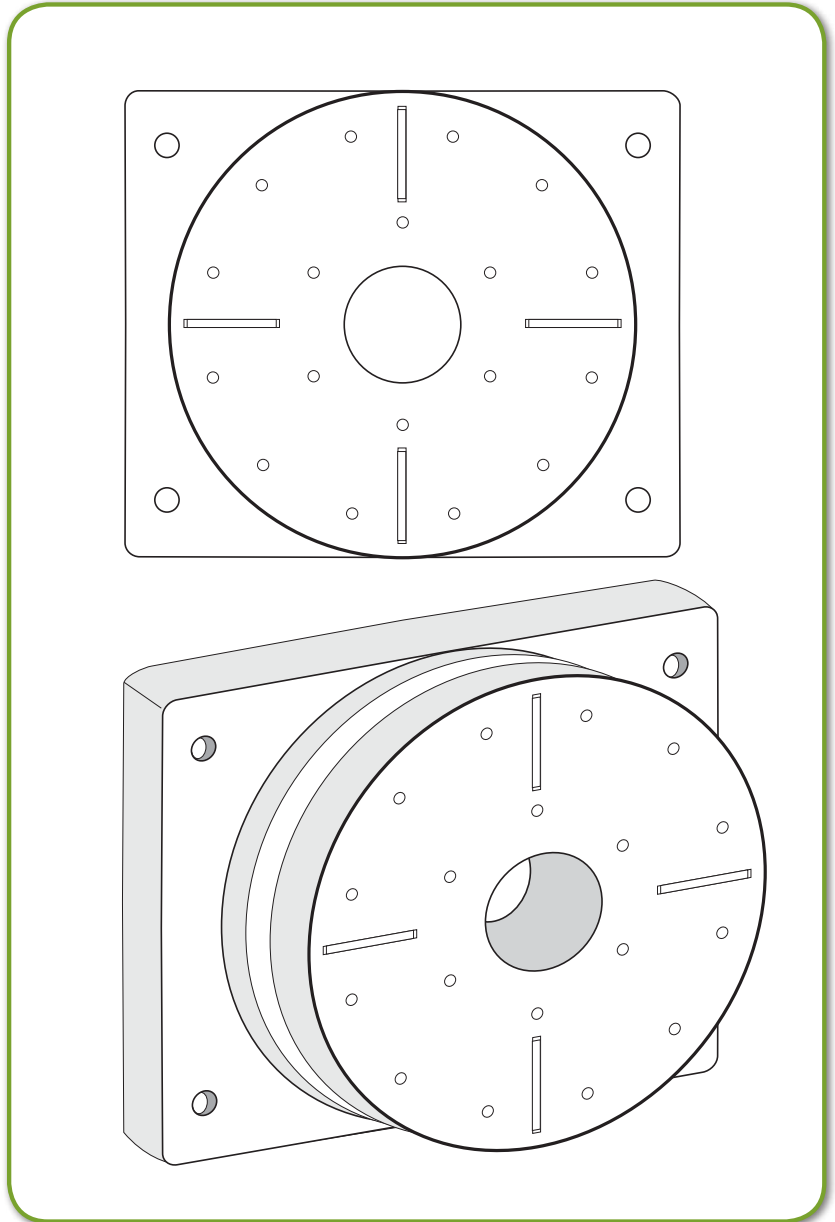

This disposable prostate template is made of Medical Grade Silicone Elastomer. The hole pattern is as shown in the figure.

**This disposable template is for one time use only.**

**CAUTION:** This product should be carefully inspected by your staff prior to clinical use and should be used by authorized personnel only.

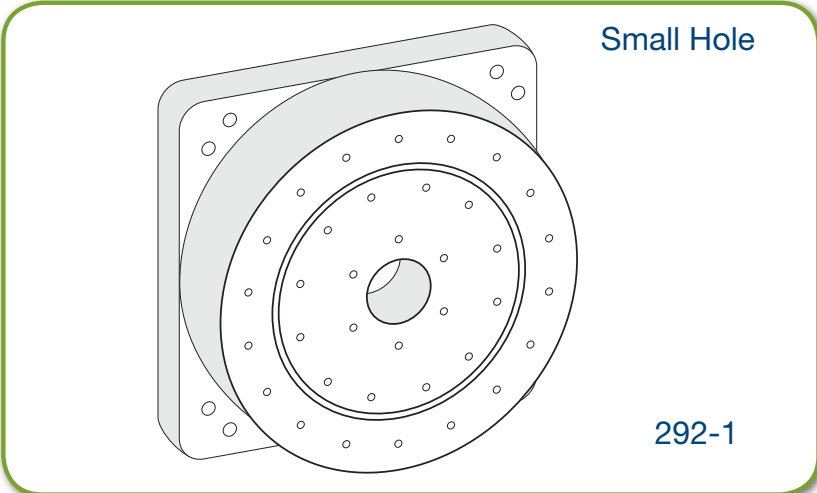
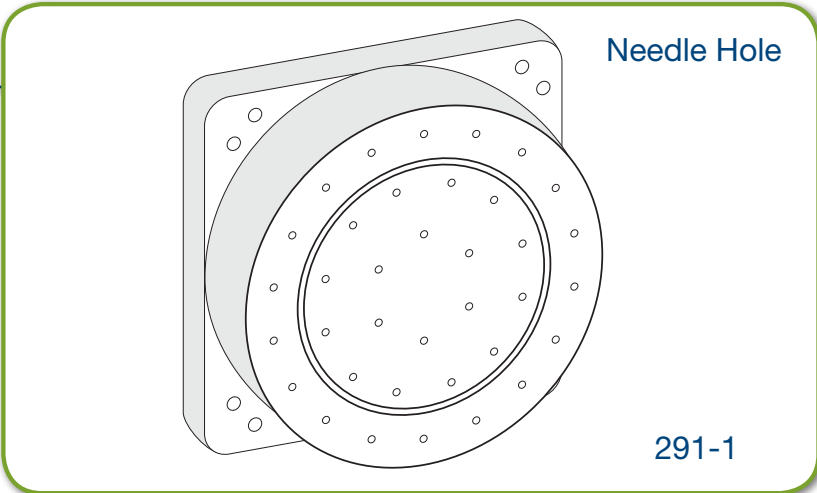

This disposable prostate template is made of Medical Grade Silicone Elastomer.  
 The hole pattern is as shown in the figure.  
**This disposable template is for one time use only.**

**Disposable Rectal Templates (with needle hole)**

Part #	
291-1	17 Gauge Non-sterile
1188	17 Gauge Sterile

**Disposable Rectal Templates (with small hole)**

Part #	
292-1	17 Gauge Non-sterile
1190	17 Gauge Sterile, Small Hole

**CAUTION:** This product should be carefully inspected by your staff prior to clinical use and should be used by authorized personnel only.



## Non-sterile Disposable Rectal Template

Part #	
345-1	16 Gauge
345-2	17 Gauge
345-3	15 Gauge
345-5	15.5 Gauge

## Sterile Disposable Rectal Template

Part #	
1084-1	17 Gauge
1084-2	15 Gauge
1084-3	16 Gauge
1084-4	15.5 Gauge

## Sterile Disposable Rectal Template Kit

Part #	
1558	15 Gauge
1678	15.5 Gauge
1664	16 Gauge
1384	17 Gauge

## 15.5G Disposable Template Accessories

Part #	
1676	Sterile in a Pouch

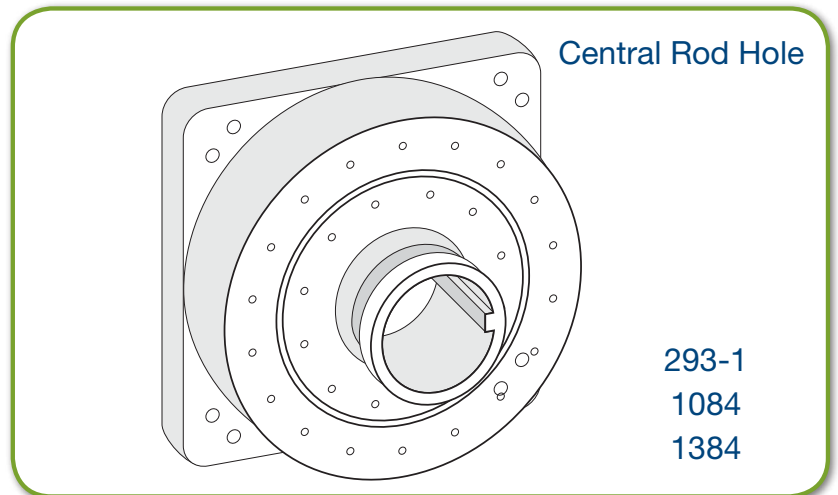

This disposable prostate template is made of Medical Grade Silicone Elastomer. The hole pattern is as shown in the figure.

**This disposable template is for one time use only.**

**NOTE:** Specify hole size when ordering (15 gauge or 17 gauge).

**CAUTION:** This product should be carefully inspected by your staff prior to clinical use and should be used by authorized personnel only.

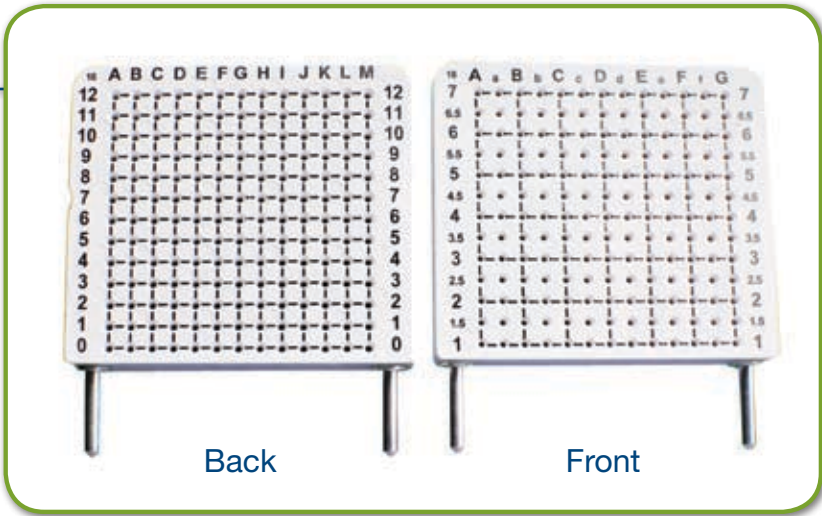

18G Templates (B&K)	
Part #	
1829	Non-sterile
1830	Sterile in a Pouch

**NOTE:** Specify hole size when ordering (15 gauge or 17 gauge).

**CAUTION:** This product should be carefully inspected by your staff prior to clinical use and should be used by authorized personnel only.



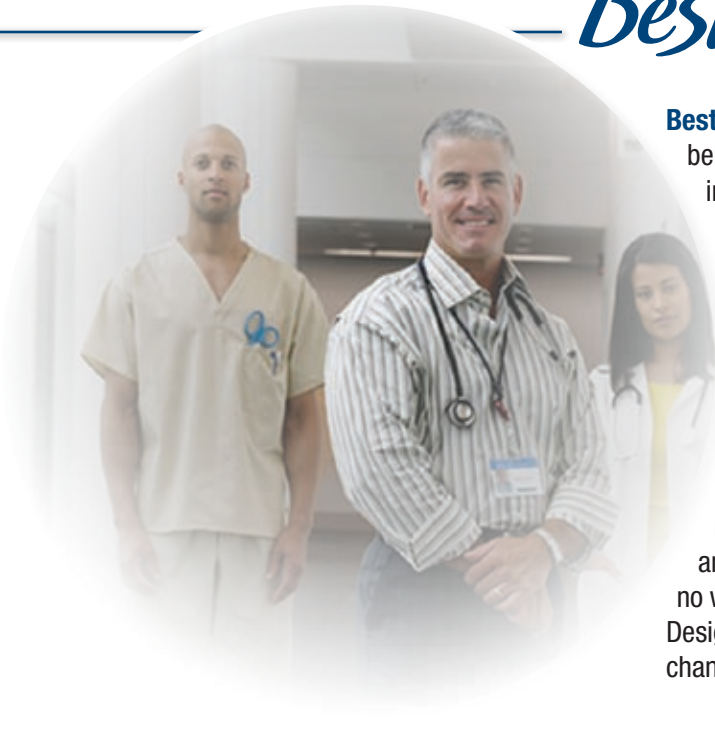

**Best Medical International, Inc.** as author/distributor, believes the technical information and statements contained in this catalog to be reliable and correct at the time of publication. However, Best Medical International, Inc., does not assume any liability for statements, information or recommendations based on/or made in reliance on the information contained in this publication.

Data provided herein are for informational purposes only and are not intended for clinical use of any nature. Use of these data in such a manner is the sole responsibility of the user, and the author/distributor of the information makes no claim or inference as to its clinical suitability and/or accuracy. Best Medical International, Inc. assumes no warranty or liability for use of this information or products. Designs and specifications are subject to modification and/or change(s).

## Terms and Conditions

**Ordering:** Orders may be placed with a purchase order number and transmitted by FAX, phone or e-mail.

**Payment:** Within 30 days.

**Freight:** FOB origin, freight prepaid and charged back through invoice.

**Returns:** Unused accessories may be returned to Best Medical International, Inc. within 15 days if found unsuitable for a particular application. No return or authorization number is necessary. A note stating the reason for return, name, and address of hospital will expedite processing of any credit.

**Note:** Best Medical International, Inc. assumes no liability for consequential damages of any kind for the material when used interchangeably with products of other manufacturers/suppliers or for any direct or indirect results and consequences of its use or misuse by the customer.

Best Medical International, Inc., reserves the right to modify the dimensions of accessories/components as well as the prices.

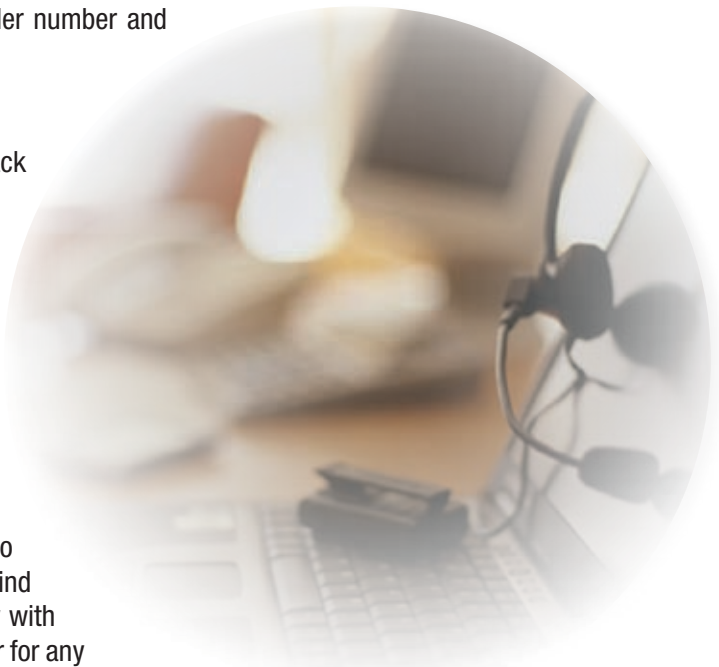

# Are you Searching for the Greatest Healthcare Company in the World?

**Look to TeamBest®!**

World population is increasing by more than 100 million per year. To meet the needs of our aging and growing population, TeamBest® companies are committed to making quality healthcare affordable and accessible globally.

**Ready to Serve Globally for All Your Needs**

Arplay Medical  
Best Cyclotron Systems  
Best Medical Africa  
Best Medical Asia  
Best Medical Canada  
Best Medical China  
Best Medical Engineering  
Best Medical Europe  
Best Medical International  
Best Medical Latin America  
Best Medical Middle East  
Best Medical Parts  
Best Medical Research  
Best Medical Russia  
Best NDT  
Best NOMOS  
Best Particle Therapy  
Best Theratronics  
Best Vascular (Novoste)  
CNMC Company  
Genetherapy Pharmaceuticals  
Huestis Diagnostics  
Huestis Medical and more...

**For more information, visit [www.teambest.com](http://www.teambest.com)**





© 2013–2020 Best Medical International, Inc.

**Best Medical International, Inc. 7643 Fullerton Road, Springfield, Virginia 22153 USA**  
**Tel: 703-451-2378 800-336-4970 Fax: 703-451-5228 [www.bestmedical.com](http://www.bestmedical.com)**